

ICC

Commercial Irrigation Controllers

Owner's Manual and Installation Instructions

- ICC-800PL Plastic Cabinet
- ICC-801PL Plastic Cabinet
(International)
- ICC-800M Metal Cabinet
- ICC-800SS Stainless Steel Cabinet
- ICC-800PP Plastic Pedestal
- ICC-800SAT Field Satellite
Controllers for IMMS™

Hunter®

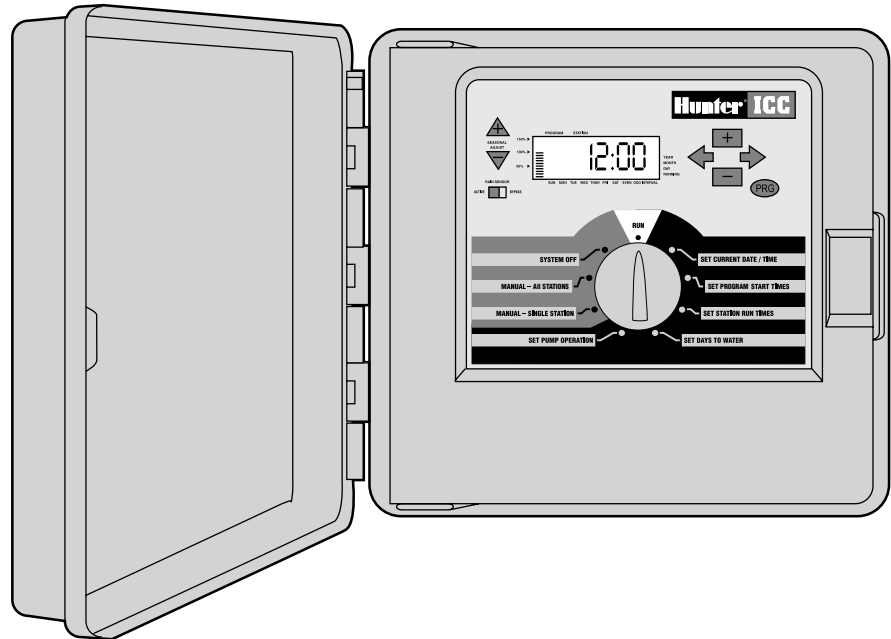

TABLE OF CONTENTS

INTRODUCTION AND INSTALLATION

Introduction	1
ICC Components.....	2-3
ICC Components – Wiring Cabinet.....	4-5
Mounting the Controller to Wall.....	6
Mounting the Controller (ICC Metal Pedestal)	7
Mounting the Controller (ICC-800PP/ICC-800SAT)	8
Connecting Valves	9
Connecting AC Power (ICC-800).....	10
Connecting AC Power (ICC-801PL and ICC-800M/ICC-800SS)	11
Connecting Station Modules.....	12
Connecting the Battery (Optional).....	13
Connecting a Master Valve	14
Connecting a Pump Start Relay	15
Connecting a Weather Sensor (Not Included).....	16
Connecting an SRR or ICR Remote Control (Not Included)	17
Connecting the Hunter Irrigation Management and Monitoring System™ (Not Included)	18
Power Failures.....	18

CONTROLLER PROGRAMMING AND OPERATION

Sprinkler System Fundamentals	19
Creating a Watering Schedule.....	20
How to Fill Out the Watering Schedule.....	20
Watering Schedule Form Example.....	21
Programming Fundamentals.....	22

TABLE OF CONTENTS (continued).....

Programming Fundamentals Examples	23
Programming the Controller.....	24
Setting the Current Date and Time.....	25
Setting Program Start Time.....	25
Eliminating a Program Start Time.....	26
Setting Station Run Times (Length of Watering for Each Area)	26
Setting Days to Water	27
Selecting Specific Days of the Week to Water.....	27
Selecting Odd or Even Days to Water.....	27
Selecting Interval Watering	28
Run.....	28
Weather Sensor Bypass	28
System Off	28
Manually Run a Single Station.....	29
Manually Run All Stations	29
One Touch Manual Start and Advance	29
Seasonal Adjustment	30
Advanced Programming Capabilities.....	31
Hidden Features.....	32-34

TROUBLESHOOTING AND SPECIFICATIONS

Frequently Asked Questions	34
Troubleshooting Guide.....	35-36
Specifications.....	37
Winterizing Your System.....	37
FCC Notice	Back Cover

INTRODUCTION

Finally, there's an affordable, full-featured indoor/outdoor controller for commercial applications.

The Hunter ICC Institutional/Commercial Controller is designed with the needs of the customer in mind, offering simplified dial programming and an impressive range of features typically found in controllers that cost twice as much.

The ICC is very much a professional grade product. The controller's large cabinet provides ample room for wiring. And the ICC is filled with essential features that landscapes demand like a rain sensor bypass circuit, primary and secondary power surge protection, seasonal adjustment/water budgeting, simultaneous program operation, programmable pump/master valve circuit, programmable rain delay, cycle and soak, four independent programs with four different day scheduling choices and eight start times each, plus much more.

The ICC is so easy to use that you'll need this user guide very little after installation. If you do have a question about the controller, refer to this booklet or to the abbreviated instructions inside the door.

You can be sure that you've chosen with confidence. The ICC is a controller that does the job efficiently and economically.

ICC COMPONENTS

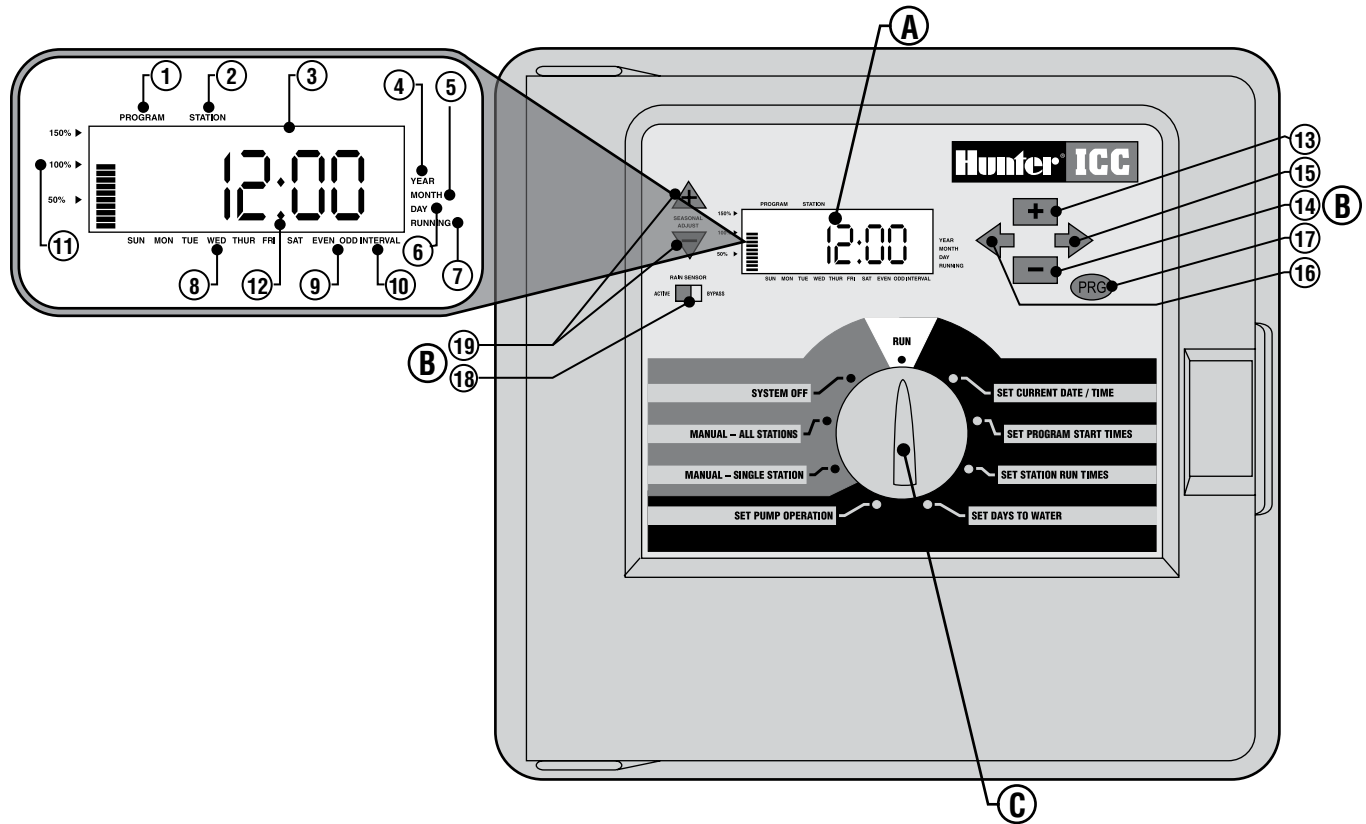

This section will give you a brief overview of some of the components on the ICC. Each item will be discussed in further detail later, however this section can be helpful in getting acquainted with the different options available.

A – LCD Display

1. **Program Selector** – Identifies the program in use A, B, C, or D.
2. **Station Number** – Identifies currently selected station number.
3. **Main Display** – Indicates various times, values, and programmed information.
4. **Year** – Arrow identifies current calendar year.
5. **Month** – Arrow identifies current calendar month.
6. **Day** – Arrow identifies current calendar day.
7. **Running** – Arrow indicates when watering is occurring.
8. **Day of the Week** – Arrow identifies days of the week to water. You can also select odd or even and an interval watering schedule.
9. **Odd/Even Watering** – Arrow identifies if odd or even watering is selected.
10. **Interval** – Arrow identifies if interval watering has been selected.
11. **Seasonal Adjust** – Displays in increments of 10%, the percentage of seasonal adjust that has been selected.
12. **Start time** – Identifies selected start time. (Only appears on LCD main display when **SET PROGRAM START TIMES** is selected.)

B – Control Buttons and Switches

13. **+** **Button** – Increases the selected flashing display.
14. **-** **Button** – Decreases the selected flashing display.
15. **➡** **Button** – Advances the selected flashing display to the next item. Also to start a manual cycle.
16. **⬅** **Button** – Returns the selected flashing display to the previous item.
17. **PRG** **Button** – Selects programs A, B, C, and D. Also to start a test program cycle.

18. **Rain Sensor Switch** – Allows user to bypass weather sensor if one is installed.

19. **▲ and ▼ Buttons** – Used to increase or decrease the seasonal adjust option.

A key feature of the ICC is its clear, easy-to-use dial design that makes programming a snap. All essential keypad functions are clearly marked to eliminate the confusion that's a characteristic of so many other controllers.

C – Control Dial

Run – Normal dial position for all controller automatic and manual operation.

Set Current Date/Time – Allows current date and clock time to be set.

Set Program Start Times – Allows 1 to 8 start times to be enabled in each program.

Set Station Run Times – Allows user to set each station run time.

Set Days to Water – Allows user to select individual days to water or to select an odd, even, or interval watering schedule.

Set Pump Operation – Allows user to turn off pump or master valve for specific stations.

Manual – Single Station – Allows user to activate a one time watering of a single station.

Manual – All Stations – Allows user to activate a one time watering of all stations or a few selected stations in a selected program.

System Off – Allows user to discontinue all programs and stop all watering until the dial is returned to the **RUN** position.

ICC COMPONENTS – WIRING CABINET

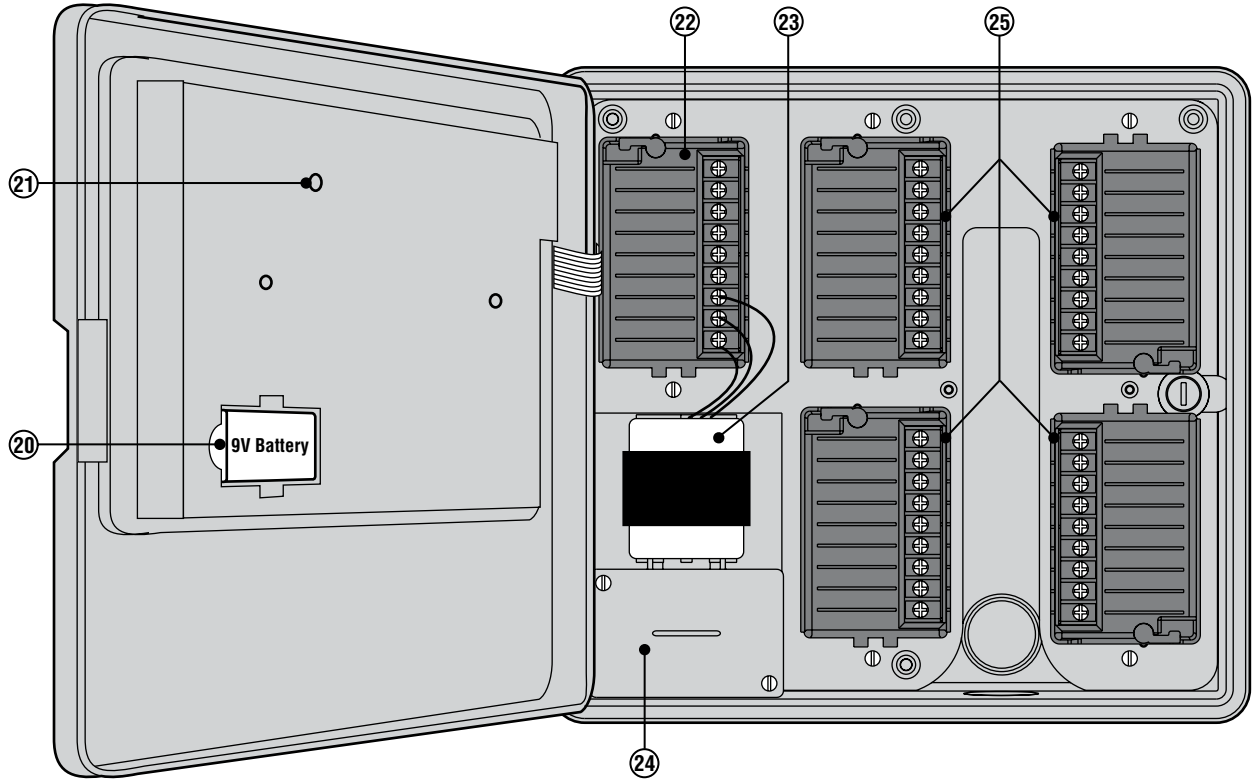

D – Wiring Cabinet

- 20. **9-Volt Battery** – The alkaline battery keeps time during power outages or if the transformer is disconnected. The user may also program the controller without AC power.
- 21. **Reset Button** – This button is used to reset the controller when installing or removing ICM modules. It can also be used to restart the controller in case of power surge or display freezing. No programmed data will be lost.
- 22. **Power Module Area** – Used to attach transformer, master valve, and other systems from their source to the controller.
- 23. **Transformer** – A transformer is installed in the controller to route AC power from the power cable to the terminal strip area and to ground the controller.
- 24. **Junction Box** – This box contains a terminal strip for connecting 115 volt and 230 volt power connections.
- 25. **Station Modules** – With the addition of 4 or 8 station ICM modules, you have the ability to run from 8 to 32 stations (plastic cabinet), and 8 to 48 stations (metal and stainless steel cabinet).



Note: Your controller is designed to work only in conjunction with black ICM station modules.

MOUNTING THE CONTROLLER TO WALL

Wall Mount for Plastic, Metal, or Stainless Steel Cabinet

All necessary hardware is included for most installations.

1. Select a location as close as possible to a standard electrical outlet that is not controlled by a light switch.
2. Using the enclosed mounting template, mark the hole locations on the wall. It should be in an easily accessible location at eye level if possible.
3. Drill a ¼" (6 mm) hole at each mark.
4. Install screw anchors into holes if attaching controller to drywall, masonry, or plaster walls.
5. Remove the door and front panel from the controller. The front door can be removed by pulling out the hinge pin.
6. Remove the protective plastic covering from around the appropriate mounting bosses on the back of the controller cabinet by pushing a screwdriver through them.
7. Holding the controller cabinet, line up the holes in the cabinet with the wall anchors or pilot holes.
8. Drive a screw through each hole and secure snugly but do not over tighten.

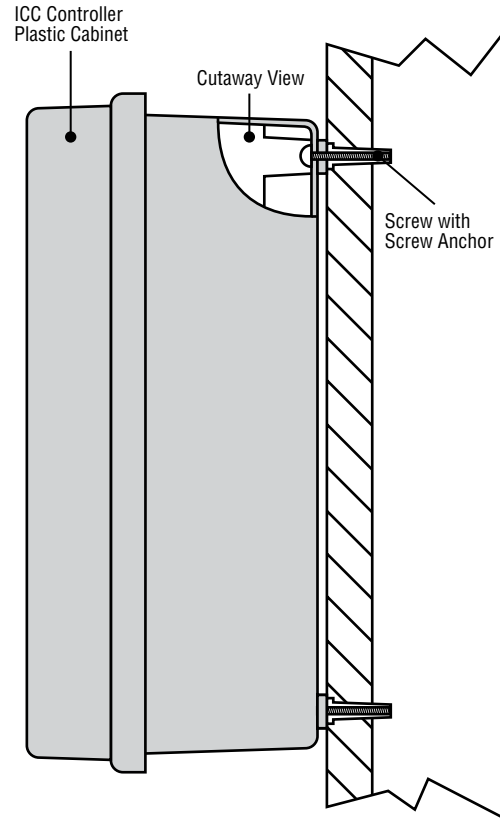

MOUNTING THE CONTROLLER (ICC METAL PEDESTAL).....

Pedestal Mount, Metal, or Stainless Steel Cabinet

1. Assemble the mounting template using the instructions provided with the pedestal.
2. Using the enclosed mounting template, locate the bolts two inches deep in the concrete pad, in the locations indicated. The pad can be any size but at least a two-foot square is recommended.
3. Level the mounting bolts before the concrete sets.
4. After the concrete sets, remove the door of the pedestal and slide the pedestal down onto the four bolts. Secure the pedestal to the bolts using the enclosed washers and nuts.
5. Remove the door and faceplate of the ICC and attach the metal cabinet of the ICC to the top of the pedestal using the enclosed hardware in the pedestal.
6. Replace the pedestal door first and then replace the faceplate and the cabinet door. The pedestal door cannot be removed or replaced when the cabinet door is closed.

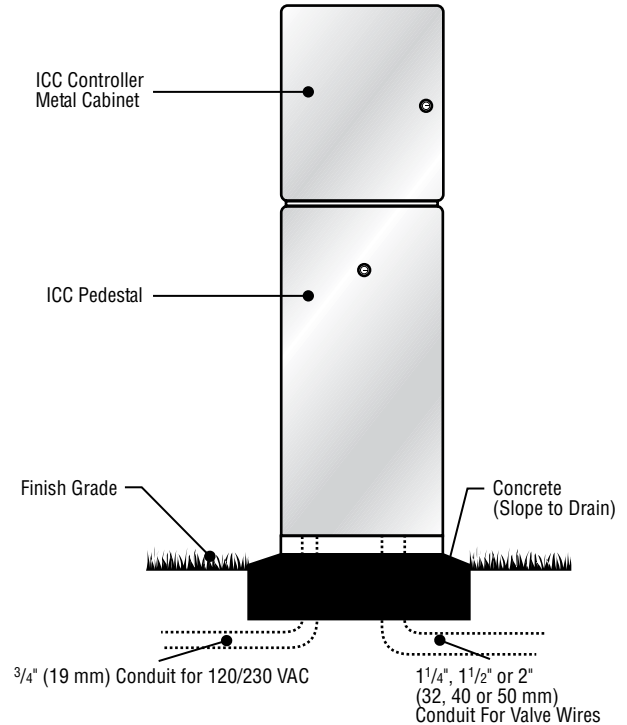

MOUNTING THE CONTROLLER (ICC-800PP/ICC-800SAT).....

Plastic Pedestal Mounting

1. Set concrete forms using the installation instructions provided with the controller. Allow 2" of conduit above the surface of the concrete pad.
2. Assemble the mounting template. Twist one nut on each of the four J-bolts and slide each bolt through the template. Put a washer and nut on each J-bolt to secure it to the template (allow 2 1/2" of thread protruding above each nut).
3. Level the mounting template before the concrete sets.
4. After the concrete sets, remove the nuts and washers from the four J-bolts slide the pedestal over the bolts. Secure the pedestal to the bolts using the enclosed washers and nuts.

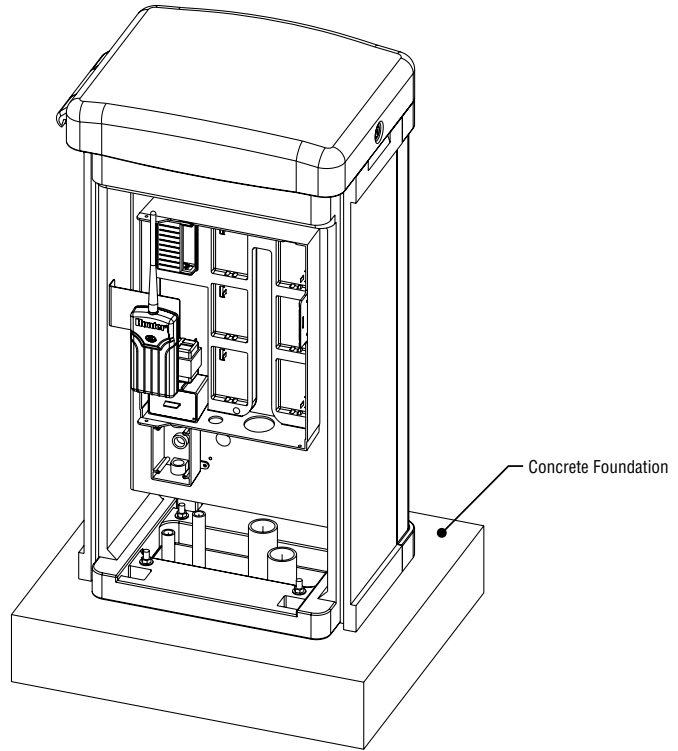
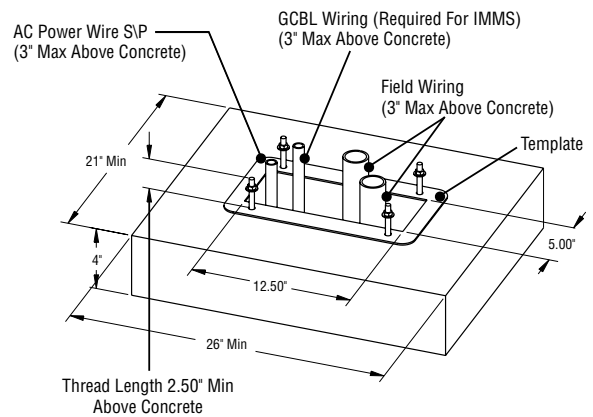

CONNECTING VALVES

1. Route valve wires between control valve location and controller.
2. At valves, attach a common wire to either solenoid wire of all valves. This is most commonly a white colored wire. Attach a separate control wire to the remaining wire of each valve. All wire splice connections should be done using waterproof connectors.
3. Open hinged faceplate on the controller to access the terminal strip area.
4. Route valve wires through the conduit and attach conduit to the controller at the large conduit opening on the right side of the bottom of the cabinet. The conduit opening has a triple knockout to accommodate 1", 1¼", or 1½" (25, 32, or 40 mm) conduit. Each section can be easily removed using a knife. Refer to the conduit sizing chart on page 31 in the Frequently Asked Questions section if you are not sure what size conduit will work for your installation.
5. Strip ½" (13 mm) of insulation from ends of all wires. Secure valve common wire to **C** (Common) terminal on any of the valve modules or power module. Then attach all individual valve control wires to appropriate station terminals.

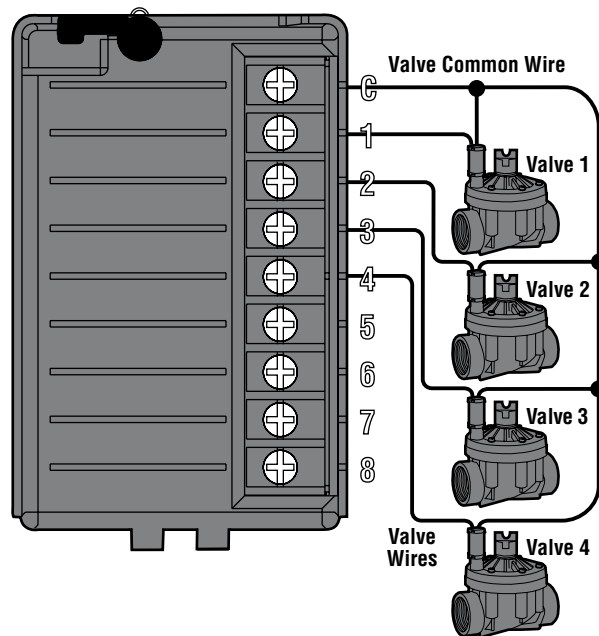

NOTE: Although it is usually best to connect all field wires prior to powering up the controller, it is not necessary with the ICC. After powering up the controller, attach the common wire to the terminal strip as described above. Then touch each wire to the terminal marked **TEST** to identify the valve location. Each valve will open electrically when the wire is touched to the **TEST** terminal. After identifying the valve location, you may then insert the wire into the appropriate terminal. This feature allows you to sequence the valves in the most logical order for the user without damaging the controller by “sparking” the wires.

CONNECTING AC POWER (ICC-800)



It is recommended that a licensed electrician perform the following power installation.

1. Remove the cover from the junction box.
2. Strip ½" off of each wire.
3. For all connections, route the wires through the conduit opening inside the junction box
4. For 120 volt connections twist the wires together using wire nuts as shown in Figure 1.
5. Cap any unused wires. Replace faceplate of junction box and screw into place.



Note: Wiring instructions for the ICC-800 SAT are included in the controller installation instructions supplied with the controller.

Figure 1 – Junction Box without Terminal Strip (120 Volt)

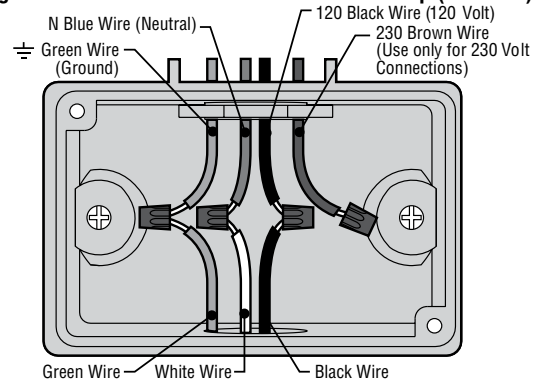

CONNECTING AC POWER (ICC-801PL AND ICC-800M/ICC-800SS)

1. Remove the cover from junction box.
2. Strip ½" off of each wire.
3. For all connections, route the wires through the conduit opening inside the junction box.
4. For 120 volt connections see Figure 3. For 230 volt connections see Figure 4.
5. Replace faceplate of junction box and screw into place.

Figure 3 – Junction Box with Terminal Strip (120 Volt)

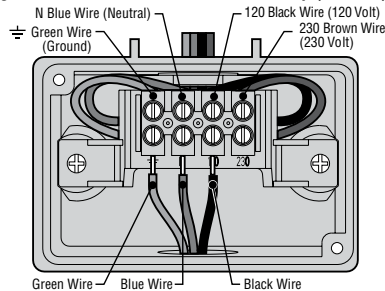
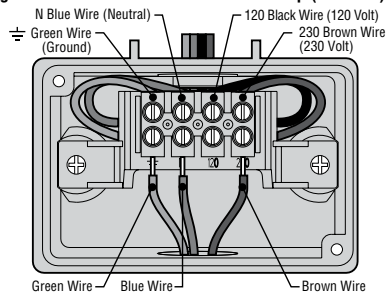

Figure 4 – Junction Box with Terminal Strip (230 Volt)



Note: The terminal strip is used in ICC-801PL (International) and ICC-800M controllers.

Grounding The ICC

The ICC is equipped with built-in electrical surge protection. For this system to function properly, the earth ground terminal on the power module must be connected to a ground rod that is driven into the earth.

Important: Use a #10 (6 mm) or #8 (10 mm) bare wire to connect the controller to the ground rod. Use a standard copper clad, 5/8" (1.6 cm) diameter, 8' (2.5 m) long ground rod.

To connect ground wire:

1. Feed the ground wire up through the large hole at the bottom of the controller cabinet (the same hole used for the valve wires).
2. Loosen the screw on the GND terminal on the power module and place the ground wire into the terminal. Tighten the screw so that the ground wire is secure (see Figure 5).

Figure 5 Power Module

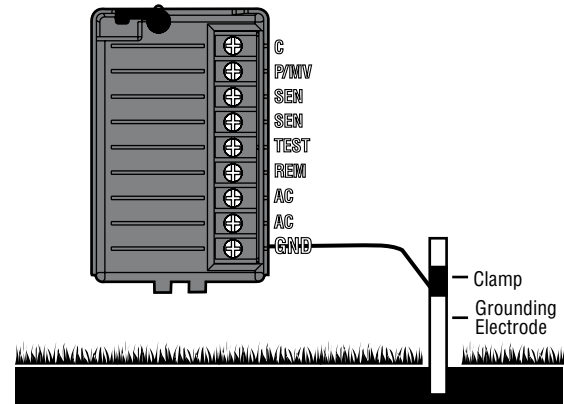

CONNECTING STATION MODULES

The ICC controller is supplied with one factory-installed station module for up to 8 stations. Additional modules may be added in increments of 4 or 8 stations to expand the controller's station capability (maximum of 32 stations with plastic cabinet and maximum of 48 stations with metal, stainless steel cabinet or plastic pedestal). Additional modules are purchased separately.

ICM modules have a Positive-Lock™ feature that fastens the module securely into the ICC. Rotating the Positive-Lock lever makes it easy to lock or unlock the module(s). In addition, the Positive Lock feature will deactivate power to the module in the unlocked position and activate power to the module when locked. No need to turn off AC power to the controller to remove or install modules.

1. Rotate the Positive-Lock lever on the module clockwise to the unlock position.
2. The module needs to be inserted into the next sequential position in the back of the controller. **Note:** If you are using a 4-station module, it must be in the last sequential position on the controller.
Example: For an area that needs 12 stations, the first module will be an 8-station and the 4-station module will be below it. Note that station numbers are identified on the back panel, not the individual modules.
3. Insert the module into the controller's expansion slot with the tab end first (opposite side with the Positive-Lock lever).
4. Push the module into the expansion slot and rotate the lever counter-clockwise (until the lever is flush with the side the module) to lock the module in place.
5. Press the reset button on the back of the front panel to reset the microprocessor to recognize additional modules.



Note: Your ICC controller is designed to work only in conjunction with Black ICM expansion modules.

Positive-Lock™ Lever

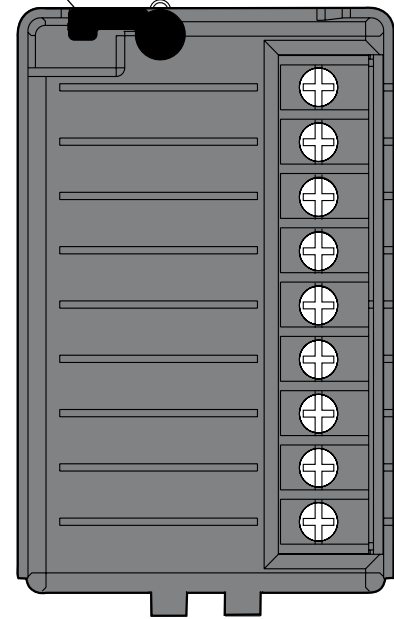

CONNECTING THE BATTERY (OPTIONAL).....

Connect a 9-volt **alkaline** battery (not included) to the battery terminals and place in the battery compartment in the controller cabinet. The battery keeps time during power outages and allows the user to program the controller without AC power. **Watering will not occur without AC power.** Since this controller has non-volatile memory, the program will be retained during a power outage even if no battery is installed.

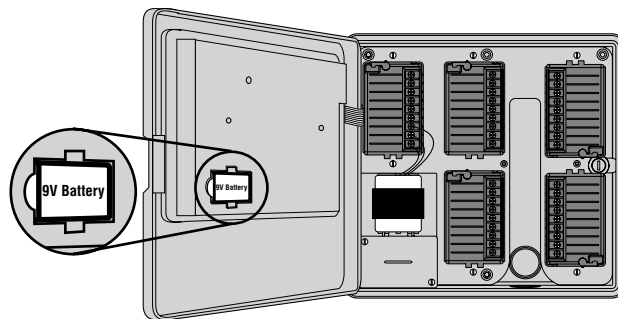

CONNECTING A MASTER VALVE



NOTE: Complete this section only if you have a master valve installed. A master valve is a normally closed valve installed at the supply point of the main line that opens only when the automatic system is activated.

1. At the Master Valve, attach the common wire to either solenoid wire of the valve. Attach a separate control wire to the remaining solenoid wire.
2. Route the wires into the controller via the field wire conduit.
3. Connect either wire from Master Valve to the **P/MV** terminal. Connect remaining wire to the **C** (Common) terminal.

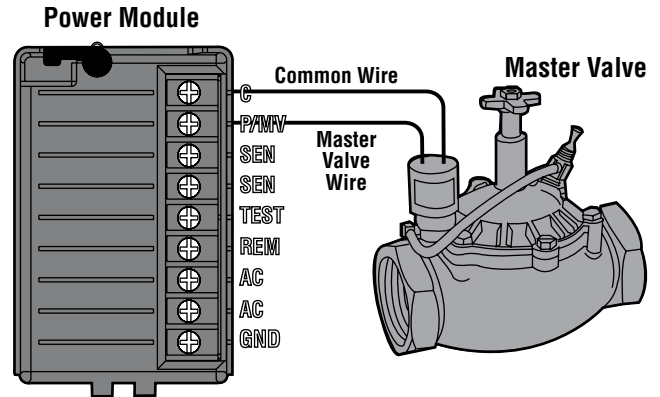

CONNECTING A PUMP START RELAY.....



NOTE: Complete this section only if you have a pump and pump start relay installed. A pump start relay is an electronic device that uses a signal current from the irrigation controller to activate a pump to provide water to your system.

The controller should be mounted at least 15 feet (4.5 m) away from both the pump start relay and the pump. When a pump is to be operated by the controller, a pump start relay must be used. Hunter offers a full range a pump start relays for most applications.

1. Route a wire pair from the pump relay into the controller housing.
2. Connect the pump relay common wire to the terminal slot **C** (Common) and the remaining wire from the pump relay to the **P/MV** screw slot.

Relay holding current draw must not exceed .28 amps.

Do not connect the controller directly to the pump – damage to controller will result.

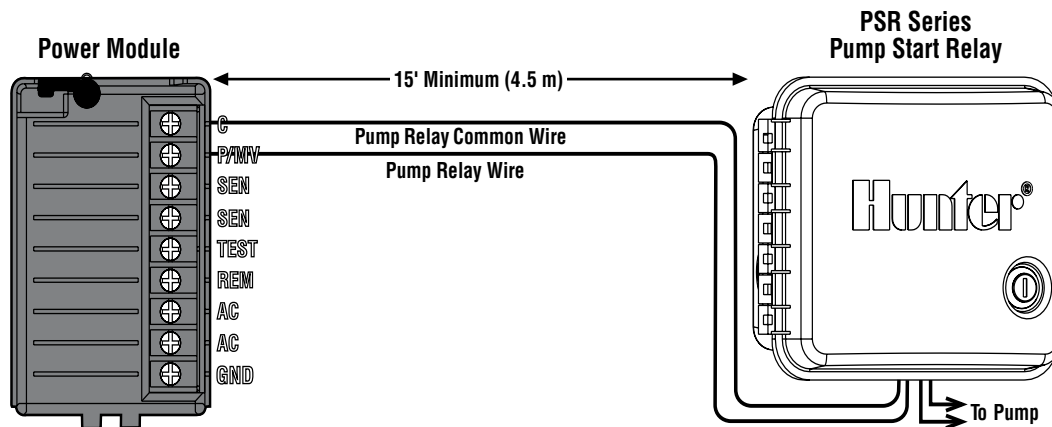

CONNECTING A WEATHER SENSOR (NOT INCLUDED)

A Hunter Mini-Clik® rain sensor or other type of micro-switch weather sensor may be connected to the ICC. The purpose of this sensor is to stop watering when precipitation is sufficient. The sensor connects directly to the controller and allows you to easily override the sensor by using the Rain Sensor bypass switch on the controller.

1. Route the wires from the rain sensor up through the same conduit used for valve wiring.
2. Remove the jumper from the two **SEN** terminals on the power module.
3. Connect one wire to the **SEN** terminal and one to the other **SEN** terminal on the power module



NOTE: If the rain sensor switch is left in the **ACTIVE** position and no sensor is connected, and the jumper has been removed, the display will read **SEN OFF** and no irrigation will occur. To eliminate this problem when no sensor is connected, leave the switch in the **BYPASS** position or install a short jumper wire between the sensor terminals.

For more information on Mini-Clik sensors, visit Hunter's Web site at <http://www.HunterIndustries.com> or contact your local dealer.

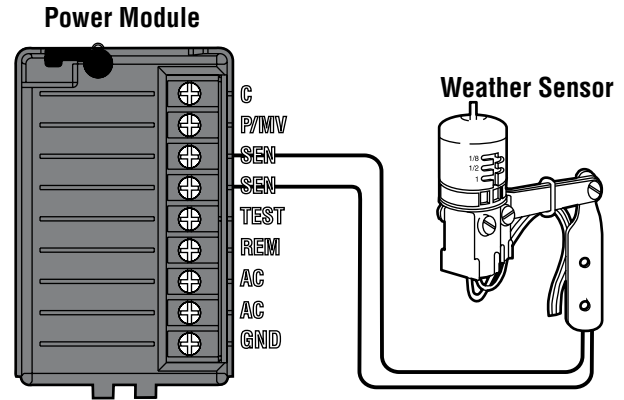

CONNECTING AN SRR OR ICR REMOTE CONTROL (NOT INCLUDED).....

The ICC controller is shipped with a SmartPort® wiring harness, allowing for fast and easy use of the Hunter SRR or ICR remote control. The remote makes it possible for contractors and end users alike to operate a system without having to walk back and forth to the controller.

To utilize the SRR/ICR Remote Control System you must install the SmartPort outlet.

1. Install a 1/2" female threaded "Tee" in the field wiring conduit approximately 12" below the ICC.
2. Feed the red, white, and blue wires of the harness through the base of the "Tee" and into the wiring compartment as shown in below.
3. Screw the SmartPort harness housing into the "Tee" as shown.
4. Access the terminal strip area and attach the red wire to the bottom most **AC** screw slot, attach the white wire to the upper **AC** screw slot and attach the blue wire to the screw slot marked "**REM.**"

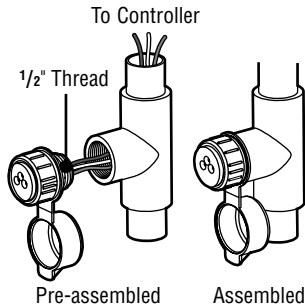

The SmartPort is now ready for remote control use. Please refer to the SRR or ICR owner's manual for further information or contact your local Hunter distributor for ordering information.

Power Module

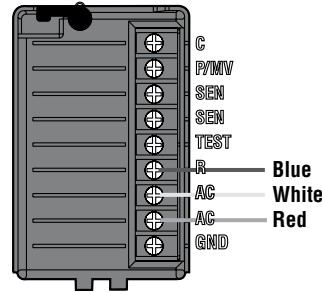

Smart Port
Wiring Harness

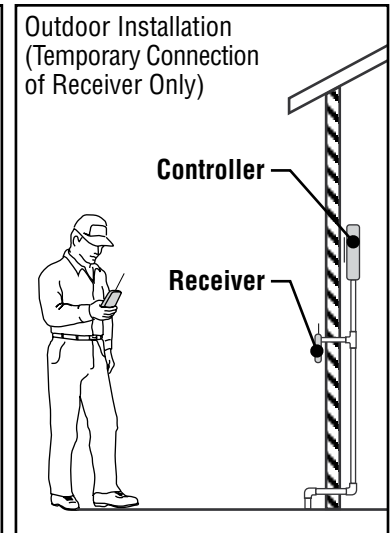
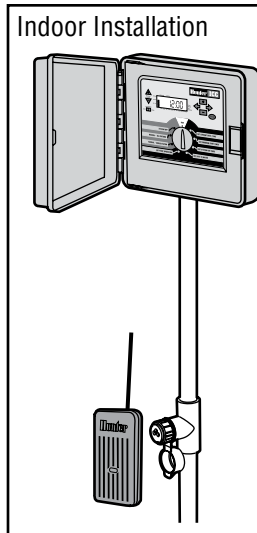

CONNECTING AN SRR OR ICR REMOTE CONTROL (CONTINUED)



NOTE: Any extension of the wiring on the SmartPort® may result in an error message in the controller display and possible malfunction of the remote unit due to radio interference. In some situations, lengthening of the harness may work fine, in others it may not work at all (it is site specific). In either case, extending the wiring harness should be done using shielded cable to minimize the possible effects of electrical noise. For easiest installation, order a new Hunter SmartPort shielded cable wiring harness (part #SRR-SCWH) with a full 25 feet of shielded cable.

CONNECTING TO THE HUNTER IRRIGATION MANAGEMENT AND MONITORING SYSTEM™ (NOT INCLUDED)

With the IMMS™, automatic irrigation systems at multiple sites or multiple controllers at a single site can be programmed for functions that would typically be handled directly at each controller. Scheduling of days to water, run times, start times, cycle and soak operations and more can now be done from a single computer at a desk miles away from the actual installation. In addition, scheduled operation of non-irrigation components also in use at these sites—e.g., lighting systems at athletic fields, fountains at shopping centers—as well as pumps and sensors can also be programmed and monitored from a single central location. A key function of the IMMS is its ability to monitor changing conditions. With the aid of such options as flow sensors, rain sensors and other weather-sensing devices, the IMMS can receive reports on the current condition at every site it is linked with and then respond with the necessary adjustments should any of those conditions go beyond the limits that have been defined. It's able to team with any or all of the standard automatic controllers in the Hunter line-up, from the SRC to the Pro-C to the ICC. Plus, it's a system that's easy and affordable to upgrade, making it possible to accommodate an expanding network of controllers. For more information on the IMMS software, contact your local Hunter dealer.

The Hunter ICC-800 SAT Field Satellite Controllers are supplied with an IMMS Site or Controller Interface already prewired to the ICC Controller. Installation is as simple as connecting AC power to and communication wires to the Controller and you're ready to operate the ICC from a central computer. Reference IMMS Installation and Operating Instructions for further information.

The ICC-800 PL, ICC-800M/-800SS are all capable of operating with IMMS. Separate Site or Controller Interface hardware is required (ordered separately). For more information on IMMS, contact your local Hunter dealer or visit the Hunter website at <http://www.HunterIndustries.com>

POWER FAILURES

Due to the possibility of power failures, the controller has nonvolatile memory to preserve the program indefinitely. If no 9-volt battery is installed, the controller will freeze time when the power goes out and resume, keeping time after power has been restored. If a battery is installed, the 9-volt battery back up will keep time so the clock and calendar will be intact for up to three days. There is no default program so there will be no surprise watering.

SPRINKLER SYSTEM FUNDAMENTALS

There are three main components that are involved with all automatic sprinkler systems that are made today. They are the **controller**, **control valves**, and the **sprinklers**.

The **controller** is what makes the whole system operate efficiently. It is technically the brain of the entire system, instructing the valves when to supply water to the sprinklers and for how long to do so. The sprinklers, in turn, will direct the water towards the surrounding plants and lawn.

The valve controls a group of sprinklers called a watering **station**. These stations are laid out in a fashion according to the type of plant life that exists there, the locations of the plants, and the maximum amount of water that can be pumped to the location. Each valve is connected via wire to the terminal strip area inside of the controller. Here the wire is connected to a number that corresponds to the valve's station number.

The controller will operate the valves in order, only one at a time. When a valve has completed its watering; it will switch to the next station that has been programmed. This process is called the watering cycle. The information pertaining to the watering times of the individual stations and the duration of them is called a **program**.

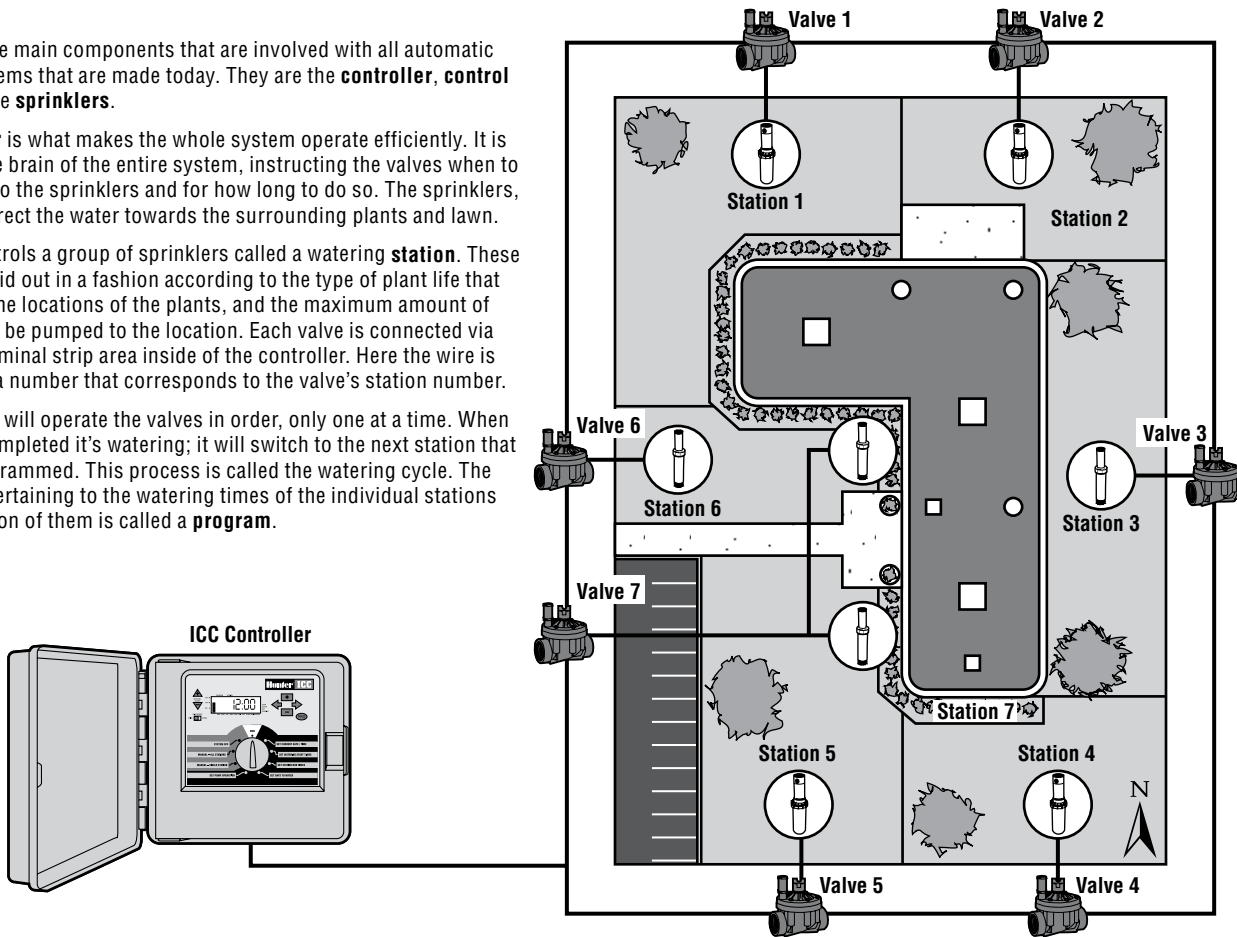

CREATING A WATERING SCHEDULE

For most consumers, it is much easier to plan your specific watering schedule onto paper before actually programming the information into the controller. It's also handy to have a written record of your programming information for easy reference.

There are some guidelines that should followed when determining when and how long to water. These factors are, the soil type, the part of the landscape being watered, weather conditions, and the types of sprinklers being used. Since there are so many different variables that can determine your individual watering schedule; it is impossible to give an exact schedule to follow. However, we have included some guidelines to help you get started.



It is usually good to water one or two hours before sunrise. Water pressure will be at optimum levels during the early morning and the water can soak into the roots of the plants while evaporation is minimal. For most plants, watering during mid-day or in the evening may cause plant damage or possibly mildew.



Keep an eye out for evidence of under- or over-watering. Over-watering is most commonly indicated by pools of water that take a long time to soak in or evaporate, while under-watered landscapes will show signs of discoloring and dryness. Make programming changes immediately when evidence is present.

HOW TO FILL OUT THE WATERING SCHEDULE

Be sure to use a pencil when filling out this form. By using the included example and the information below, you should have all the information you need to construct your personal water schedule. There is an example of a completed form on the following page.

Station Number and Location – Identify the station number, location, and the type of plant that is being watered.

Watering Day – Identify whether you want to use a calendar day, interval, or an odd or even day schedule. For a calendar day schedule, circle the day of the week in which watering is desired. For an interval

schedule, indicate the desired interval number. And for an odd or even day schedule, simply mark the corresponding box.

Program Start Times – Indicate the time of day that the program will begin. Each program can have 1 to 8 start times. However, one start time can run an entire program.

Station Run Time – Indicate the run time (1 minute to 2 hours or up to 12 hours on program D) for each station. Write “OFF” for any station that you do not want to operate in the program.

Keep this schedule in a safe place for quick reference later, rather than scrolling through program information on the controller.

HUNTER ICC		PROGRAM A						PROGRAM B						PROGRAM C						PROGRAM D									
CALENDAR DAY		SU	MO	TU	WE	TH	FR	SA	SU	MO	TU	WE	TH	FR	SA	SU	MO	TU	WE	TH	FR	SA	SU	MO	TU	WE	TH	FR	SA
INTERVAL DAY								3																					
ODD/EVEN DAY		ODD <input checked="" type="checkbox"/>			EVEN <input type="checkbox"/>			ODD <input type="checkbox"/>			EVEN <input type="checkbox"/>			ODD <input type="checkbox"/>			EVEN <input type="checkbox"/>			ODD <input type="checkbox"/>			EVEN <input type="checkbox"/>						
PROGRAM START TIMES		1	6:00 AM						9:00 AM																				
		2	OFF						OFF																				
		3	OFF						OFF																				
		4	OFF						OFF																				
		5	OFF						OFF																				
		6	OFF						OFF																				
		7	OFF						OFF																				
		8	OFF						OFF																				
STATION	LOCATION	STATION RUN TIME						STATION RUN TIME						STATION RUN TIME						STATION RUN TIME									
1	NW Corner	0:15																											
2	NE Corner	0:15																											
3	Rear	0:10																											
4	SE Corner	0:15																											
5	SW Corner	0:15																											
6	Front Walk	0:10																											
7	Shrubs							0:20																					
8																													
9																													

PROGRAMMING FUNDAMENTALS.....

A watering program can be created to operate valves in numerical sequence one at a time. All that is required to create a watering program is to:

1. Select a program (**A**, **B**, or **C**) by pressing the **PRG** button on the controller (it is recommended to start with **Program A**).
2. Set a program start time (only one program start time is required to activate a watering program).
3. Set the run time for each valve assigned to the program and
4. Set the days that you would like the watering program to run.

For the controller and its selected program to operate automatically, there are three components that must exist: When to water (or **Program Start Times**), how long to water (or **Station Run Times**), what day of the week to water (or **Days to Water**).

We have included an example that will better illustrate the operation of a program. Let's say you have a program start time set for 6:00 AM. Stations 1 and 2 are going to have a run time of 15 minutes and Station 3 is set for 10 minutes. Please note that Stations 4, 5, etc. have not been included in this program, we will water them on separate programs.

Going back to our previous example, at 6:00 AM the controller will activate the watering cycle. The sprinklers on Station 1 will run for 15 minutes and then shut off. The controller will automatically activate Station 2 sprinklers. These sprinklers will also run for 15 minutes and then shut off. Then, watering on Station 3 will begin. The sprinklers will turn on for 20 minutes and shut off. The controller will run all Stations sequentially with Station 6 concluding the program at 7:30 AM.

As shown in the above example, only **one** program start time was required to run the three different stations. The controller automatically moves to the next station without the need for additional start times.

We realize that many consumers will have variations in their plant watering needs, so at Hunter we equipped the ICC with four different programs: A, B, C, and D. These programs are completely independent of each other and give you the ability to have four coexisting timers in one controller. The only exception is program D, which can be used as a drip irrigation program. Any station used in program A, B, or C can not be used in program D. This prevents the accidental assignment of a rotor or spray zone to program D, the drip program, which could lead to excessive watering.

Program D can run concurrently with Program A, B, or C. For example, using more than one program would enable you to water the lawn Stations 1, 2, and 3 on program A, Station 4 to soak the flowers with drip irrigation on program D, and Station 5 to water the shrubs on program B. However, it is not absolutely necessary to use this feature. Many users prefer the simplicity of using one program for all their watering needs. The additional programs are provided for your convenience should the need arise.

PROGRAMMING FUNDAMENTALS EXAMPLE

HUNTER ICC		PROGRAM A						PROGRAM B							
CALENDAR DAY		SU	MO	TU	WE	TH	FR	SA	SU	MO	TU	WE	TH	FR	SA
INTERVAL DAY								3							
ODD/EVEN DAY		ODD <input checked="" type="checkbox"/>			EVEN <input type="checkbox"/>			ODD <input type="checkbox"/>			EVEN <input type="checkbox"/>				
PROGRAM START TIMES	1	6:00 AM						9:00 AM							
	2	OFF						OFF							
	3	OFF						OFF							
	4	OFF						OFF							
	5	OFF						OFF							
	6	OFF						OFF							
	7	OFF						OFF							
	8	OFF						OFF							
STATION	LOCATION	STATION RUN TIME						STATION RUN TIME							
1	NW Corner	0:15													
2	NE Corner	0:15													
3	Rear	0:20													
4	SE Corner	0:15													
5	SW Corner	0:15													
6	Front Walk	0:10													
7	Shrubs							0:20							
8															
9															

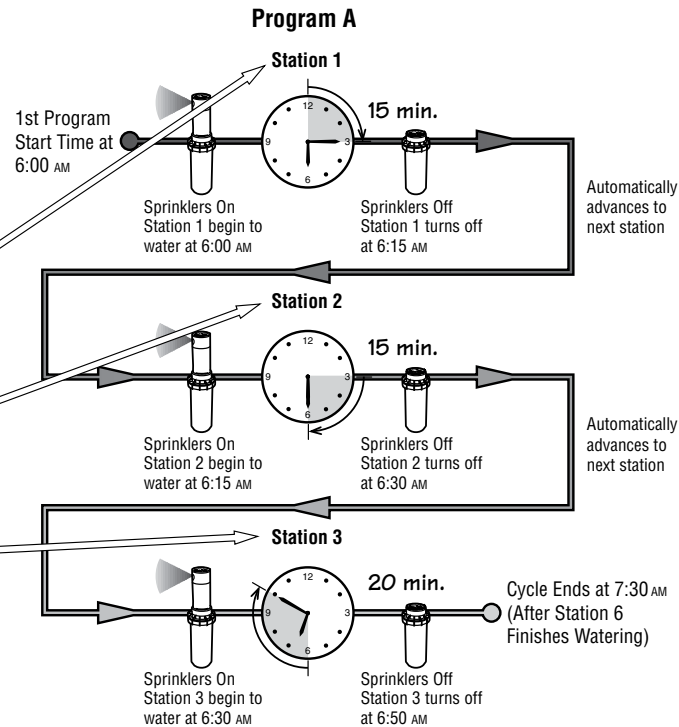

Total Cycle of Program A = 50 minutes

PROGRAMMING THE CONTROLLER

Two key features of the ICC that make programming a snap are its clear, easy-to-read LCD display and its easy-to-use dial design.

The ICC display shows time and day when the controller is idle. The display changes when the dial is rotated to indicate the specific programming information to enter. When programming, the flashing portion of the display can be changed by pressing the **+** or **-** buttons. To change something that is not flashing, press **←** or **→** until desired field is flashing.

The ICC controller offers maximum scheduling flexibility including four programs, each with up to 8 daily start times, permitting plants with different watering requirements to be separated on different day schedules. Multiple start times permit morning, afternoon and evening watering, perfect for the establishment of new lawns and thirsty annual flowers. A built in 365-day calendar clock accommodates odd/even watering restrictions without requiring monthly reprogramming. Or, just simply designate the days of the week you want to water or use the convenient day interval watering. The ICC makes it easy.

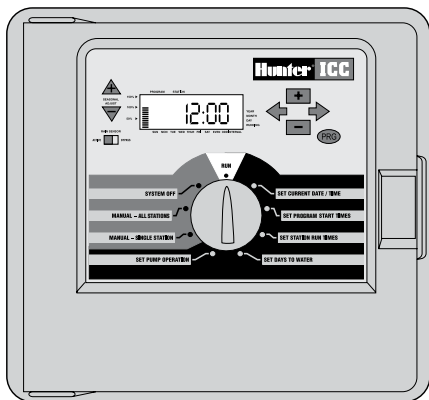

NOTE: A basic programming rule is that whatever symbol or character is flashing will be the item programmed. For instance, if the hour is flashing when setting the time, the hour can be changed or programmed. For illustration purposes, flashing characters are in **GRAY type. Setting The Current Date And Time**

To activate a program in your controller, you must enter the following information:

1. Set current day and time—turn dial to **SET CURRENT DATE/TIME**.
2. Set what time of day you would like the program to start—turn dial to **SET PROGRAM START TIMES**.
3. Set how long each valve will water—turn dial to **SET STATION RUN TIMES**.
4. Set the day(s) you would like the program to water—turn dial to **SET DAYS TO WATER**.



NOTE: All stations operate in numerical order. Only one program start time is required to activate all stations in the watering program.

Setting The Current Date And Time

1. Turn the dial to the **SET CURRENT DATE/TIME** position.
2. The current year will be flashing in the display. Use the **+** and **-** buttons to change the year. After setting the correct year, push the **➡** button to proceed to setting the month.
3. The month and day will be in the display. The month will be flashing. Use the **+** and **-** buttons to change the month. Press the **➡** button to proceed to setting the day.
4. The day will be flashing: Use the **+** and **-** buttons to change the day of the month. (The day of the week is automatically indicated by an arrow pointing to the bottom of the display pointing to the day.) Press the **➡** button to proceed to setting the time.
5. The time will be displayed: Use the **+** and **-** buttons to select AM, PM, or 24 hr. Press the **➡** button to move to hours. Hours will be flashing. Use the **+** and **-** buttons to change the hour shown on the display. Press the **➡** button to move onto the minutes. Minutes will be flashing. Use the **+** and **-** buttons to change the minutes shown in the display. The date, day, and time have now been set.

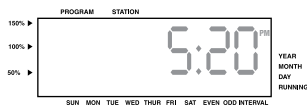
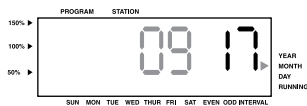
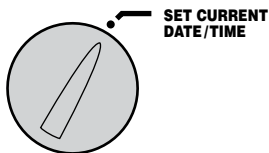

Setting Program Start Time

1. Turn the dial to the **SET PROGRAM START TIMES** position.
2. The factory preset is set on program **A**. If necessary you can select program **B**, **C**, or **D** by pressing the **PRG** button.
3. Use the **+** and **-** buttons to change the start time. (Advances in 15-minute increments.)
4. Press the **➡** button to select the next start time, or **PRG** for the next program.

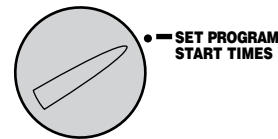

NOTE: Regardless of the order in which the start times are entered, the ICC will always arrange the start times in chronological order when the dial is moved off the **SET PROGRAM START TIMES** position.

One start time will activate stations sequentially in that program one at a time. Multiple start times in a program can be used for separate morning, afternoon, or evening watering cycles. Do not enter a start time for each station.

PROGRAMMING THE CONTROLLER (continued)

Eliminating A Program Start Time

With the dial set to the **SET PROGRAM START TIMES** position, push the **+** and **-** buttons until you reach 12:00 AM (Midnight). From this position push the **-** button once to reach the **OFF** position.

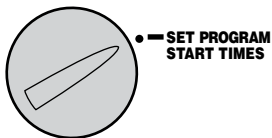



NOTE: If a program has all eight start times turned off, then that program is off (all other program details are retained). Because there are no start times, there will be no watering with that program. This is a convenient way to stop watering on one program only without turning the dial to the off position.

Setting Station Run Times (Length of Watering for Each Area)

1. Turn the dial to the **SET STATION RUN TIMES** position.
2. The display will show the last program selected (A, B, C, or D). You can switch to another program by pressing the **PROG** button.
3. Use the **+** and **-** buttons to change the station run time on the display.
4. Press the **➡** button to advance to the next station.
5. Repeat steps 4 and 5 for each station.
6. You may set station run times from 1 minute to 2 hours. If the station is assigned program D, the run time can be set for up to 12 hours.
7. You can move between programs while staying on the same station. However, it is recommended that one program is completed before going on to the next program. Jumping between programs can be confusing and may result in program errors.

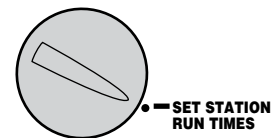



NOTE: If a station is assigned a run time on program A, B, or C, then that station cannot be assigned to Program D. If this is attempted, the word **USED** will appear in the display. Likewise, a station with a run time on Program D cannot be assigned to program A, B, or C. This is to prevent the accidental assignment of a rotor or spray zone to the D program which is normally reserved for drip applications.

Setting Days To Water

1. Turn the dial to the **SET DAYS TO WATER** position.
2. The display will show the last program selected (**A, B, C, or D**) the station number selected, and the run time for that station will be flashing. You can switch to another program by pressing the **PRG** button.
3. The controller displays currently programmed active day schedule information. This dial position provides four different water day options: choose to water on specific days of the week, you can choose interval watering, or choose to water on odd days or even days. Each program can only operate using one type of water day option.

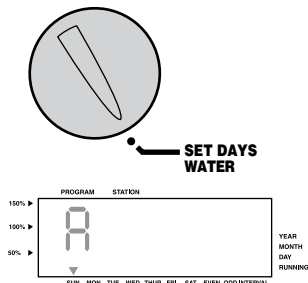

Selecting Specific Days of the Week to Water

1. With the arrow cursor on a specific day (the cursor always starts with Sunday), press the **▶** button to activate a particular day of the week to water. Press the **■** button to cancel watering for that day. After pressing a button the cursor automatically advances to the next day.
2. Repeat step 1 until desired days have been selected. The selected days arrows will show on the display to indicate their status as **ON**. The last solid arrow is the last day of watering for that program.

Selecting Odd or Even Days to Water

This feature uses a numbered day of the month for watering instead of specific days of the week (Odd days 1st, 3rd, 5th, etc.; Even days 2nd, 4th, 6th, etc.).

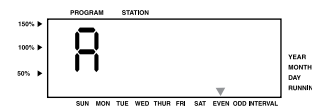

1. Press the **▶** button until the arrow cursor is above either **EVEN** or **ODD** on the display.
2. Press the **+** button to select or the **■** button to cancel either **Odd Days** or **Even Days**. The previous selected days of the week will revert to active if **Odd Days** or **Even Days** is cancelled.



NOTE: The 31st of any month and February 29th are always "off" days if Odd watering is selected.

PROGRAMMING THE CONTROLLER (continued)

Selecting Interval Watering

This feature is convenient if you want to have a more consistent watering schedule without having to worry about the day of the week or the date. The interval you select is the amount of days between watering. The days remaining indicates how many days until the next watering. For example if you select an interval of 4 with 1 days remaining, watering will begin tomorrow at the scheduled time.

1. Turn the dial to **SET DAYS TO WATER** the triangle above Sunday should be flashing.
2. Use the **▶** button and move the flashing arrow cursor above the **INTERVAL** designator.
3. Press the **+** button. The display will now show two numbers, the interval and the days remaining in the interval.
4. The number of days between waterings, or the interval will be flashing. Use the **+** and **-** buttons to select the number of days desired between waterings.
5. Press the **▶** button. The days remaining in the interval are now flashing. Use the **+** and **-** buttons to select the number of days until the next desired watering. One day remaining means it will water the next day.

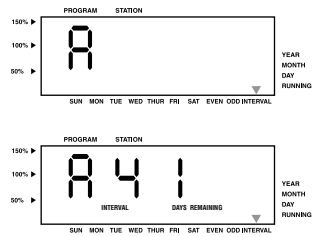

After programming, set dial to **RUN** to enable automatic execution of all selected programs and start times.

Run

After programming is complete, turn the dial to **RUN** to enable automatic execution of all selected programs and start times. **Watering will not occur unless dial is in the RUN position.**

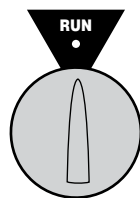

Weather Sensor Bypass

With this built-in feature, there is no need for an additional manual bypass switch when using rain sensors (the ICC works with the Hunter Mini-Clik®, plus some other rain, wind, and freeze sensors on the market today). If the system is preventing system operation (or no sensor is installed and the switch is in the **ACTIVE** position), **SEN OFF** will be displayed. Simply move the switch to **BYPASS** and the weather sensor will be bypassed. This allows you to use the system.

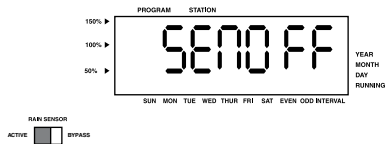

System Off

Valves currently watering will be shut off after the dial is turned to the **SYSTEM OFF** position for two seconds. All active programs are discontinued and watering is stopped. To return controller to normal automatic operation, simply return dial to **RUN** position.

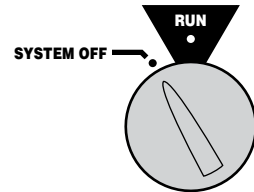

Manually Run a Single Station

1. Turn the dial to the **MANUAL-SINGLE STATION** position.
2. Station run time will flash in the display. Use the **▶** button to move to the desired station. You may then use the **+** and **-** buttons to select the amount of time for a station to water.
3. Turn the dial to the **RUN** position to run the station (only the designated station will water, then controller will return to automatic mode with no change in the previously set program).

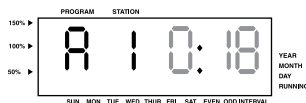
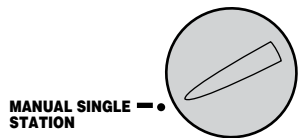

Manually Run All Stations

1. Turn the dial to **MANUAL-ALL STATIONS**.
2. You can select program **A, B, C, or D** by pressing the **PRG** button.
3. Press the **▶** button until desired starting station is displayed.
4. Station run time will flash in the display. Use the **+** and **-** buttons to select the amount of run time for the station to water if different from the run time displayed.

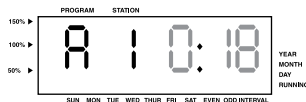
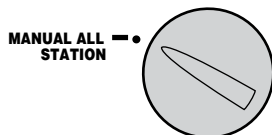

5. Use the **▶** button to move to the next station.
6. Repeat steps 3 and 4 to customize each station if desired.
7. Press the **▶** button until desired starting station is displayed.
8. Return the dial to **RUN** (custom program will water the entire program beginning with the station number last left in the display, then controller will return to automatic mode with no change in the previously set program).



NOTE: The station that is on the display when you turn the dial to **RUN** will be the first station to run. The controller will then proceed to water in sequential order only. It will not water previous stations. Example: If you turn the dial to **RUN** with the display reading station 3, the controller will water Stations 3 through 9 in the program, but not return to Stations 1 and 2.

One Touch Manual Start and Advance

You can also activate all stations to water without using the dial.

1. Hold down the **▶** button for 2 seconds.
2. This feature automatically defaults to program **A**. You can select program **B, C or D** by pressing the **PRG** button.
3. The station number will be flashing. Press the **◀** or **▶** button to scroll through the stations and use the **+** and **-** buttons to adjust the station run times. (If no buttons are pressed during step 2 or 3, the controller will automatically begin program **A**.)
4. Press the **▶** button to scroll to the station you wish to begin with. After a 2 second pause, the program will begin.

This feature is great for a quick cycle when extra watering is needed or if you would like to scroll through the stations to inspect your system.

PROGRAMMING THE CONTROLLER (continued)

Seasonal Adjustment

Seasonal Adjust is used to make global run time changes without reprogramming the entire controller. This feature is perfect for making small changes that are necessary as the weather changes without reprogramming the entire controller. For instance, hotter times of the year may require a bit more water. Seasonal adjust can be increased so that the stations will run longer than the programmed time. Conversely, as Fall approaches, the seasonal adjust can be reduced to allow for short watering durations.

To use the seasonal adjust, simply press the ▲ or ▼ seasonal adjust buttons to set the percentage desired. The watering run time can be adjusted from 10% to 150% of original program. The seasonal adjust can be changed at any time regardless of the programming dial position. To view the new adjusted run time, simply turn the rotary dial to the **SET RUN TIMES** position, the displayed run time will be updated accordingly as the seasonal adjustment is made. The seasonal adjustment will affect all station run times programmed



NOTE: The controller should always be initially programmed in the 100% position.

ADVANCED PROGRAMMING CAPABILITIES.....

There are four advanced features available to customize the ICC to more complex watering requirements. Two of these features are “hidden” to make accidentally programming them nearly impossible.

Set Pump/Master Valve Operation

The default is for all stations to have the master valve/pump start circuit **ON**. The master valve/pump start can be set **ON** or **OFF** by station, regardless of which program the station is assigned. This feature may be utilized on systems where it is desirable for a booster pump not to operate with certain zones.

To program pump operation:

1. Turn the dial to **SET PUMP OPERATION** position.
2. Press the **+** or **-** buttons to toggle the master valve/pump start **ON** or **OFF** for the specific station.
3. Press the **▶** button to advance to the next station.
4. Repeat steps 2 and 3 for all necessary stations.

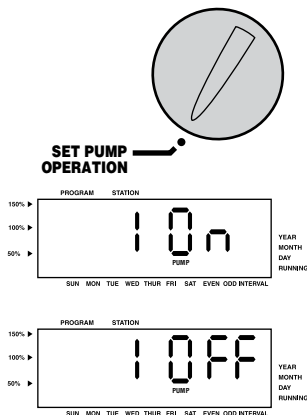

Programmable Rain Off

This feature permits the user to stop all programmed waterings for a designated period from 1 to 7 days. At the end of the Rain Delay, the controller will resume normal automatic operation.

1. Turn the dial to the **SYSTEM OFF** position.
2. Press the **+** button and a 1 will be displayed and the **DAYS** icon will illuminate. The 1 will be blinking at this point.
3. Press **+** as many times as needed to set the number of days off desired (up to 7).
4. To validate this setting (and to make sure the controller comes back on after the period is over), turn the dial back to the **RUN** position at which time, **OFF**, a number and the **DAYS** icon all remain on.
5. Leave the dial in the **RUN** position.

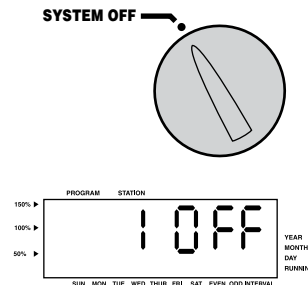

NOTE: The days off remaining will decrease at midnight of each day. When it goes to zero, the display will show the normal time of day and normal irrigation will resume at the next scheduled start time.

HIDDEN FEATURES



NOTE: The hidden features described below can only be entered by starting with the dial in the **RUN** position and holding down various buttons while the knob is turned to various setup positions. This makes it virtually impossible for someone to stumble onto these features.

Cycle and Soak

The Cycle and Soak feature allows the user to split each station's run time into more usable, shorter duration waterings. This feature is particularly applicable for slopes and tight soil (such as clay) because Cycle and Soak will help prevent excessive run off. You should enter the Cycle time as a fraction of the station's watering time and the Soak time as the minimum soak required before watering the next portion. The total number of cycles is determined by taking the total programmed station run time and dividing it by the Cycle time.

For example: Suppose Station 1 required 20 minutes worth of water but after only 5 minutes, runoff occurred. However, after 10 minutes all the water was absorbed. The solution would be to program 20 minutes for the Station Run Time, 5 minutes for the Cycle time, and 10 minutes for the Soak. Station 1 will then water for 5 minutes and then the rest of the stations in the program will water. After all the other stations have watered the controller will check to see if Station 1 had soaked for at least 10 minutes. If it had, then Station 1 will water for another 5 minutes. This process would continue to repeat itself until Station 1 watered 4 times for 5 minutes each time, a total of 20 minutes.

1. Start with the dial in the **RUN** position.
2. Press and hold the **+** button down while turning the dial to the **SET STATION RUN TIMES** position.
3. Release the **+** button. At this point, the display will show the station number, the cycle time will be blinking. The **CYCLE** and soak icons will also be lit.
4. Press the **+** or **-** buttons to increase or decrease the cycle time from 1 to 60 minutes in 1 minute increments.
5. Press the **➡** key to advance to the next station and its cycle time.
6. Pressing the **⬅** key will display the previous station and its cycle time.
7. Return the Dial to the **RUN** position after setting all the cycle and soak times.

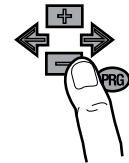
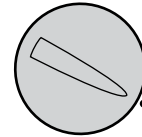
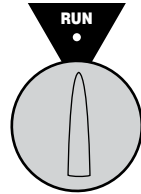

Setting the Soak Times

It is only necessary to set a **SOAK** time if the accumulated **CYCLE** times on any single program will not provide an adequate soak time. For instance, if the sum of the cycle times for all stations in a program exceeds 10 minutes and each station will require no more than 20 minutes of soak time, then the accumulated cycle times are sufficient and no soak time will need to be programmed. However, if the necessary soak time did exceed the 10 minutes, then a soak time must be entered for those stations requiring a longer soak between waterings. The soak time default is 10 minutes.

Pressing the **PRG** button at any time while in the cycle time setup will allow the user to enter the soak time setup for that station. Pressing **PRG** again will go back to the cycle time setup. The soak time works identically to the cycle time setup except that the **SOAK** icon will be on as opposed to the **CYCLE** icon.



NOTE: If the dial is moved from the **SET STATION RUN TIMES** position, then the entire sequence of going back to **RUN** and holding the **PRG** key down must be repeated to reenter the cycle and soak setup. The cycle and soak feature is a station dependent function and will be used whenever the station operates regardless of which program or programs the station is assigned.

Programmable Delay Between Stations

This feature allows the user to insert a delay between when one station turns off and the next station turns on. This is very helpful on systems with slow closing valves or on pump systems that are operating near maximum flow or have slow well recovery.

1. Start with the dial in the **RUN** position.
2. Press and hold the **PRG** button down while turning the dial to the **SET STATION RUN TIMES** position.
3. Release the **PRG** button. At this point the display will show a delay time for all stations in seconds, which will be blinking. The **DELAY** icon shall also be lit at this time.
4. The display will show "SEC". Use the **+** and **-** buttons to increase or decrease the delay time between 0 and 10 minutes in 1 second increments.
5. Pressing either the **←** button or the **→** button will allow for programming a longer delay between stations. The display will show the delay in minutes.
6. Press the **+** and **-** buttons to increase or decrease the delay time from 0 to 10 hours in 5 minute increments.
7. Return the dial to the **RUN** position.

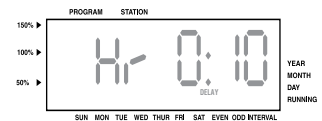
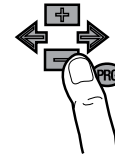
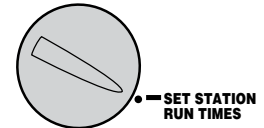
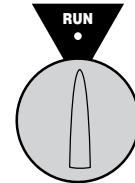

HIDDEN FEATURES (continued).....



NOTE: The Master Valve/Pump Start circuit will operate during the first 20 seconds of any programmed delay to aid in the closing of the valve and to avoid unnecessary cycling of the pump. It is recommended that a pressure relief valve be installed on the system should this 20 second delay be too long for a particular system. Consult your pump contractor or supplier for details.

Clearing Controller's Memory / Resetting Controller

If you feel that you have misprogrammed the controller, there is a process that will reset the memory to factory defaults and erase all programs and data that have been entered into the controller.

1. Turn the dial to the **RUN** position.
2. Remove battery.
3. Hold down the **■** button, the **▶** button, and the **PRG** button simultaneously.
4. While holding down the three buttons, press and release the reset button on the back of the front panel, then release the three buttons.

Hold all buttons and reset until display flashes 12:00. All the memory has been cleared and the controller may be reprogrammed.

Hunter Quick Check™

Irrigation professionals are continuously looking for ways to more efficiently and effectively diagnose programs in the field. Instead of having to physically check each field wiring circuit for potential problems, the user can run the Hunter Quick Check™ circuit test procedure. This circuit

FREQUENTLY ASKED QUESTIONS.....

What Size Field Wiring Conduit Should I Use?

Locate the size conduit across the top and the wire size along the side. Where the two intersect on the table tells you approximately how many wires will fill the conduit. Example: 49 wires of 18 AWG will fit in 1½" conduit.

diagnostic procedure is very beneficial because of its ability to aid in quickly identifying "shorts" commonly caused by faulty solenoids or when a bare common wire touches a bare station control wire.

To initiate the Hunter Quick Check test procedure; Press the **+**, **■**, **▶**, **PRG** buttons. In the standby mode, the LCD will display all segments (helpful when troubleshooting display problems). Press the **■** button to begin the Quick Check test procedure. Within seconds, the system searches all stations in an effort to detect a high current path through the station terminals. When a field wiring short is detected, an ERR symbol preceded by the station number will momentarily flash on the controller LCD display. After the Hunter Quick Check completes running this circuit diagnostic procedure, the controller returns to the automatic watering mode.

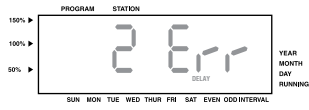

Test Program

The ICC allows the user a simplified method for running a test program. This feature operates each station in numerical sequence, from the lowest to the highest. You can start with any station. This is a great feature to check the operation of your irrigation system.

To initiate the test program:

1. Press and hold the **PRG** button. The station number will be flashing.
2. Press the **◀** or **▶** button to scroll to the station you would like the test program to start with. Use the **+** or **■** button to set the run time up to 15 minutes. The run time needs to be entered only once.
3. After a 2 second pause, the test program will begin.

CONDUIT SIZES			
Wire Size	1" (25 mm)	1¼" (32 mm)	1½" (40 mm)
18 AWG	20	34	49
16 AWG	16	30	42
14 AWG	10	18	25
12 AWG	7	15	20

TROUBLESHOOTING GUIDE

PROBLEM	CAUSES	SOLUTIONS
The controller repeats itself or continuously watering even when it should not be on/controller cycles over and over.	Too many start times (user programming error).	Only one start time per active program is required. Refer to "Setting Program Start Times" on page 24.
There is no display.	Check AC power wiring.	Correct any errors.
The display reads "ERR".	Electrical noise is entering the system.	Check the SmartPort® wiring harness. If the wires were extended then they will need to be replaced with shielded cable. Contact your local distributor for information on shielded cable.
The display reads "P ERR".	There is a ground fault in the wire to the pump start or master valve.	Check the master valve or pump start wire for continuity. Replace or repair the broken wire. Check that all wire connections are good and water tight.
The display reads a station number and ERR, such as "2 ERR".	There is a ground fault in the wire leading to that station.	Check the station wire for continuity. Replace or repair broken wire. Check that all wire connections are good and water tight.
The display reads "NO AC".	There is no AC power present to operate controller/valves.	Check to see if the transformer is properly installed.
The display reads "SEN OFF".	The rain sensor is interrupting irrigation or not installed.	Slide the Rain Sensor switch on front panel to the bypass position to bypass rain sensor circuit.

TROUBLESHOOTING GUIDE (continued)

PROBLEM	CAUSES	SOLUTIONS
The controller does not start automatically.	Possible programming error.	Check to make sure start time is entered correctly (note AM/PM setting as well). Check to make sure watering day is active.
Rain sensor will not shut off system.	Incorrect sensor type wired directly into sensor circuit. (Jumper installed)	Make sure sensor is microswitch type such as Mini-Clik®.
The controller recognizes 48 stations all the time.	Microprocessor requires reset.	Make sure AC power is connected. Reset controller using method described on page 34.
The controller does not respond to all the stations. Example, the controller has 24 stations but the display will only go to 16 stations.	Controller does not recognize modules.	Turn off the power to the controller and remove the battery. Check all module connections to the controller. Power the controller back up. The microprocessor will recognize all modules.
The controller is only recognizing eight stations when multiple modules are installed and/or there are not enough start times for all stations.	The dial is in the START TIMES position and not the STATION RUN TIMES position (see page 26).	Be sure dial is in correct position. Total number of stations can be easily checked by placing dial in SET STATION RUN TIMES position and pressing the back arrow.
Controller has display but will not activate zone valves.	Primary power to controller incorrectly wired. Controller receiving voltage too low for valve operation.	Check and correct 110 or 220 volt connection. 110 volt may be incorrectly wired as 220 volt.

SPECIFICATIONS

Operating Specifications

- Station Run Time: 1 minute to 2 hours (in 1-minute increments) on programs A, B, and C. Up to 12 hours on program D. The longer run time on program D is primarily to accommodate drip irrigation applications.
- Start Times: 8 per day, per program, for up to 32 daily starts.
- Watering Schedule: 7-day calendar, interval watering up to a 31-day interval or true odd or even day programming, made possible by the 365-day clock/calendar.

Electrical Specifications

- Transformer Input: 120 VAC, 60Hz (230 VAC, 50/60 Hz International Use)
- Transformer Output: 25 VAC, 1.5 amp
- Station Output: 24 VAC, .56 amps per station

- Maximum Output: 24VAC, 1.4 amps (includes Master Valve Circuit)
- Battery Backup: 9-volt alkaline battery (not included) used only for time keeping during power outages, the nonvolatile memory maintains program information

Dimensions

Plastic Cabinet

Height: 11" (28 cm)
Width: 12" (30.5 cm)
Depth: 3¾" (9.5 cm)

Metal Cabinet

Height: 15¾" (40 cm)
Width: 11⅜" (29 cm)
Depth: 4½" (11.4 cm)

Metal Pedestal

Height: 30" (76 cm)
Width: 11⅜" (29 cm)
Depth: 4" (10 cm)

Default Settings

All stations are set to zero run time. This controller has a nonvolatile memory that retains all entered program data even during power outages, without need for a battery.

WINTERIZING YOUR SYSTEM

In regions within the country where the frost level falls below the depth of the installed piping, it is common for these systems to be "winterized". Several methods can be used to drain the water from the system. If the blow out method is used it is recommended that a qualified licensed contractor perform this type of winterization.

WARNING! WEAR ANSI APPROVED SAFETY EYE PROTECTION ! Extreme care must always be taken when blowing out the system with compressed air. Compressed air can cause serious injury, including serious eye injury from flying debris. Always wear ANSI approved safety eye protection and do not stand over any irrigation components (pipes, sprinklers, and valves) during blow out. **SERIOUS PERSONAL INJURY MAY RESULT IF YOU DO NOT PROCEED AS RECOMMENDED.**

FCC NOTICE.....

This controller generates radio frequency energy and may cause interference to radio and television reception. It has been type tested and found to comply with the limits for a Class B computing device in accordance with the specifications in Subpart J of Part 15 of FCC Rules, which are designed to provide reasonable protection against such interference in a residential installation. However, there is no guarantee that interference will not occur in a particular installation. If this equipment does cause interference to radio or television reception, which can be determined by turning the equipment off and on, the user is encouraged to try to correct the interference by one or more of the following measures:

- Reorient the receiving antenna
- Move the controller away from the receiver
- Plug the controller into a different outlet so that controller and receiver are on different branch circuits

If necessary, the user should consult the dealer or an experienced radio/television technician for additional suggestions. The user may find the following booklet prepared by the Federal Communications Commission helpful: "How to Identify and Resolve Radio-TV Interference Problems." This booklet is available from the U.S. Government Printing Office, Washington, D.C., Stock No. 004-000-00345-4 (price – \$2.00 postpaid).