





RAIN BIRD®

ESP-LXME Controller



Installation, Programming & Operation Guide



Symbols

-  **NOTE:** Symbol is intended to alert the user to important operating functionality, installation or maintenance instructions.
-  **WARNING:** Symbol alerts the user to the presence of electricity or electromagnetic energy which may constitute a risk of electric shock, radiation exposure or other hazard.
-  **CAUTION:** Symbol is intended to alert the user to important instructions or conditions that could seriously affect irrigation effectivity or controller operation.
-  **DIAL:** Symbol indicates that the user is required to turn the dial on the controller to the appropriate setting in order to follow subsequent instructions as described in that section.
-  **REPEAT:** Symbol indicates that a repetition of previous steps or actions may be required in order to continue or complete the controller programming process.

Safety Information

-  **WARNING:** A circuit breaker or cutoff switch must be provided in the fixed wiring to isolate the controller.
-  **WARNING:** The current date and time on the controller is retained by a long-life lithium battery, which must be disposed of in accordance with local regulations.

Regulatory Information

This equipment has been tested and found to comply with the limits for a Class B digital device, pursuant to Part 15 of the FCC Rules. These limits are designed to provide reasonable protection against harmful interference in a residential installation.

This equipment generates, uses, and can radiate radio frequency energy and, if not installed and used in accordance with the instructions, may cause harmful interference to radio communications. However, there is no guarantee that interference will not occur in a particular installation.

If the equipment does cause harmful interference to radio or television reception, which can be determined by turning the equipment off and on, the user is encouraged to try to correct the interference by the following measures:

- Reorient or relocate the receiving antenna.
- Increase the separation between the equipment and the receiver.
- Connect the equipment into an outlet on a circuit different from that to which the receiver is connected.
- Consult the dealer or an experienced radio/TV technician for help.

Changes or modifications not expressly approved by Rain Bird Corporation could void the user's authority to operate the equipment.

This product was FCC certified under test conditions that included the use of shielded I/O cables and connectors between system components. To be in compliance with FCC regulations, the user must use shielded cables and connectors and install them per instructions.

For technical assistance contact Rain Bird at 800 RAINBIRD (1-800-724-6247) U.S. and Canada

Visit us on the web at www.rainbird.com

Contents

Section A - Introduction & Overview	1
Welcome to Rain Bird	1
ESP-LXME Controller	1
Controller Features.....	1
Controls, Switches and Indicators.....	2
Basic Operation.....	3
ESP-LXME Model Variants.....	4
Base Modules	4
BM-LXME Base Module	4
FSM-LXME Flow Smart Module.....	4
ESPLXM-SM Station Modules.....	5
Programming Overview.....	6
Irrigation Controller Definitions.....	6
Programs.....	6
Watering Days	6
Watering Start Time	6
Station Run Time	6
Programming Chart	6
Fill Out Programming Chart	6
Storing the Programming Chart.....	7
Remote Programming	7
Programming Checklist	8
Set Up Hardware	8
Set Up Programs.....	8
Set Up Programs (Optional).....	8
Review Setup	8
Optional Setup.....	8
AUTO.....	9
Automatic Operation	9
Alarm Conditions	10
FloWatch™ Alarms.....	10
Review Alarm Messages	10
Resetting the Controller	11

Section B - Basic Programming.....	13
Program Select Switch	13
Select Program	13
Weather Sensor Bypassed/Active Switch	13
Bypass or Activate Weather Sensor	13
Set Current Date	14
Set Current Time	15
Set Watering Start Times	16
Select Days to Water	17
Station Run Times.....	18
Section C - System Diagnostics	19
Test All Stations/Check System	19
Confirm Programs.....	19
Program Summary	19
Review Program.....	20
Program Run Time	23
Station Run Time	24
Test All Stations.....	25
Wiring Diagnostics	26
Raster Wiring Test.....	26
Weather Sensor Status.....	28
Master Valve Status	29

Section D - Advanced Programming.....	31
Seasonal Adjust %.....	31
Adjust Individual Program.....	31
Adjust By Month.....	32
Select Months to Adjust.....	32
Select Programs To Adjust.....	33
Delay Watering.....	34
Rain Delay.....	34
Calendar Day Off.....	35
Water Windows.....	36
Station Delay.....	37
Weather Sensor.....	38
Local Weather Sensor Types.....	38
Custom Pause Sensors.....	38
Custom Prevent Sensors.....	38
Weather Sensor Setup.....	39
Advanced Settings.....	40
Watering Day Cycles.....	40
Watering Cycle Definitions.....	40
Custom, Odd, Odd no 31st, Even.....	40
Cyclical Days.....	41
Set Up SimulStations™.....	43
Set SimulStations™ for Program.....	43
Set SimulStations™ for Controller.....	44
Station Sequencing.....	45
Station/MV Settings.....	46
Station Settings.....	46
Set Up Cycle+Soak™.....	48
Module Status.....	49
MV Settings.....	50

Section E - Flow Management.....	51
Set Flow Units.....	51
FloManager™ Overview.....	52
FloManager™ Requirements.....	52
Set Up and Use FloManager™.....	52
Enable (Or Disable) FloManager™.....	52
Set FloManager™ Flow Rate.....	54
Set Station Flow Rates Manually.....	55
FloWatch™ Overview.....	56
FloWatch™ Configuration.....	56
Flow Sensor Hardware Installation.....	56
Flow Smart Module.....	56
Connect Flow Sensor.....	58
Module Programming.....	59
Setup Flow Sensor.....	59
SEEF and SELF Settings and Actions.....	60
Station Flow Rates.....	63
Learn Flow Automatically (All Stations).....	63
Learn Flow Automatically (Custom Stations).....	65
Set Station Flow Rates Manually.....	67
Clear Flow Rates.....	68
Enable (or Disable) FloWatch™.....	69
Module Status.....	70
View and Clear Flow Alarms.....	70
View Station Flow Alarms.....	70
View Mainline Flow Alarms.....	71
Clear Flow Alarms.....	72
View Flow Rates.....	73
View and Clear Flow Logs.....	74
View Current Flow.....	75

Section F - Options & Special Features	77
Set Language	77
Set Hours Mode	77
Backup and Recall Programs	78
Store Default Programs	78
Recall Default Programs.....	79
Delayed Recall	80
Section G - Auxiliary Operation.....	81
Clear Programs	81
Clear Individual Program.....	81
Clear All Programs.....	82
Restore Defaults.....	83
Manual Watering	84
Start Station Manually	84
Start Program Manually	85
MV Water Window.....	86
Set Up MV Water Window.....	86
Manually Opening a MV	88
Test All Stations.....	89
OFF.....	90
Adjust Display Contrast.....	90
Close the Master Valve.....	91

Section H - Installation	93
Prepare For Installation	93
Installation Checklist	93
Check Box Contents.....	93
Gather Installation Tools	94
Install the Controller	95
Select Location for Controller	95
Access Controller Cabinet.....	96
Remove Cabinet Door and Front Panel	96
Remove Modules	97
Mount Controller.....	98
Connect Power to the Controller.....	99
Surge Protection and Grounding.....	99
Connect Power Source	99
Re-install Front Panel.....	101
Install Modules	102
Install BM-LXME Base Module.....	102
Install Station Module.....	103
Dynamic Station Numbering	104
Connect Field Wiring	105
Connect Valve Wires	105
Connect Local Weather Sensor	106
Complete Installation.....	108
Install Front Door	108
Verify Field Installation	108

this page intentionally left blank

Section A - Introduction & Overview

Welcome to Rain Bird

Thank you for purchasing your new state-of-the-art Rain Bird ESP-LXME controller.

For over seven decades Rain Bird has led the irrigation industry in meeting water management needs by providing the highest quality products and services available.

ESP-LXME Controller

Your new Rain Bird controller is designed to provide years of highly manageable irrigation control.

The ESP-LXME is an irrigation controller designed for commercial use. It accommodates up to 8 or 12 stations and through the addition of Station Modules can easily be expanded to address up to 48 total stations.

Controller Features

The ESP-LXME controller has a variety of advanced features to help you manage water efficiently, including:

- Flow, power, and station priority management
- Large variety of user-configurable irrigation program options to meet the most demanding irrigation needs while still addressing municipal mandates and restrictions
- Upgrade features including Station Modules, IQ Central Control Communication and ET Manager Cartridges.
- Supports one local weather sensor input.
- Outdoor-rated plastic cabinet which can be upgraded to the optional metal cabinet (LXMM) and pedestal (LXMMPED).
- UL, CUL, CE and C-TICK certified.



Controls, Switches and Indicators

Key operational features of the ESP-LXME Controller front panel:

1 Programming Dial

Used for programming and to turn the controller on and off.

2 Weather Sensor Switch

Set the controller to obey or ignore input from an optional sensor. See Section B, Weather Sensor Bypassed/Active Switch for more details.

3 Program Select Switch

Select Watering Program A, B, C, or D. See Section B, Program Select Switch for more details.

4 Display

Displays time of day during normal operation; shows commands during programming; shows active station and remaining run time during watering.

5 Programming Buttons

Press buttons to enter and change program information.

- Press and HOLD buttons to accelerate settings for hours, minutes and seconds, dates or percentages.

6 Alarm Light

Illuminates to indicate various types of alarm conditions. See Alarm Conditions for more details on how to review and clear alarms.

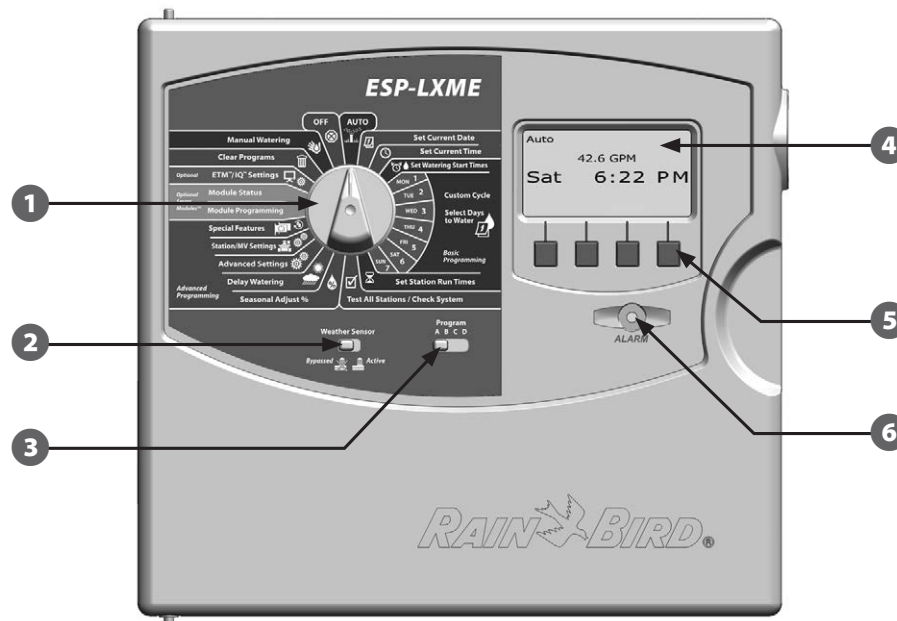

ESP-LXME Controller Front Panel Features

Basic Operation

Valves (or stations) operate at times as specified by irrigation programs.

The controller sends power to the first valve solenoid to open. When finished, the controller signals the solenoid to shut off its valve and then signals the second valve solenoid to open. Then when the second valve is finished, the third valve will begin watering and so on.

! **NOTE:** The ESP-LXME's SimulStations feature allows you to operate multiple stations at the same time. See section D for more details.

! **NOTE:** The ESP-LXME's Cycle+Soak feature may delay valve operation. See Section D, Set Up Cycle+Soak for more details.

The ESP-LXME lets you set a delay between stations. For example, if you set a one minute delay, station 1 will run until finished, followed by a one minute delay. Then station 2 will run, followed by another one minute delay, and so on. See Section D, Station Delay for more details.

The order in which stations are selected to operate depends on the following settings:

- Station Sequencing settings
- Station flow rate (FloManager)
- Station priorities
- POC flow rate (FloManager)
- Station run times
- SimulStation settings
- Station program assignment

! **NOTE:** When using Station Sequencing by priorities, set station priorities higher for stations you want selected earlier in a program and lower for stations you want selected later in a program.

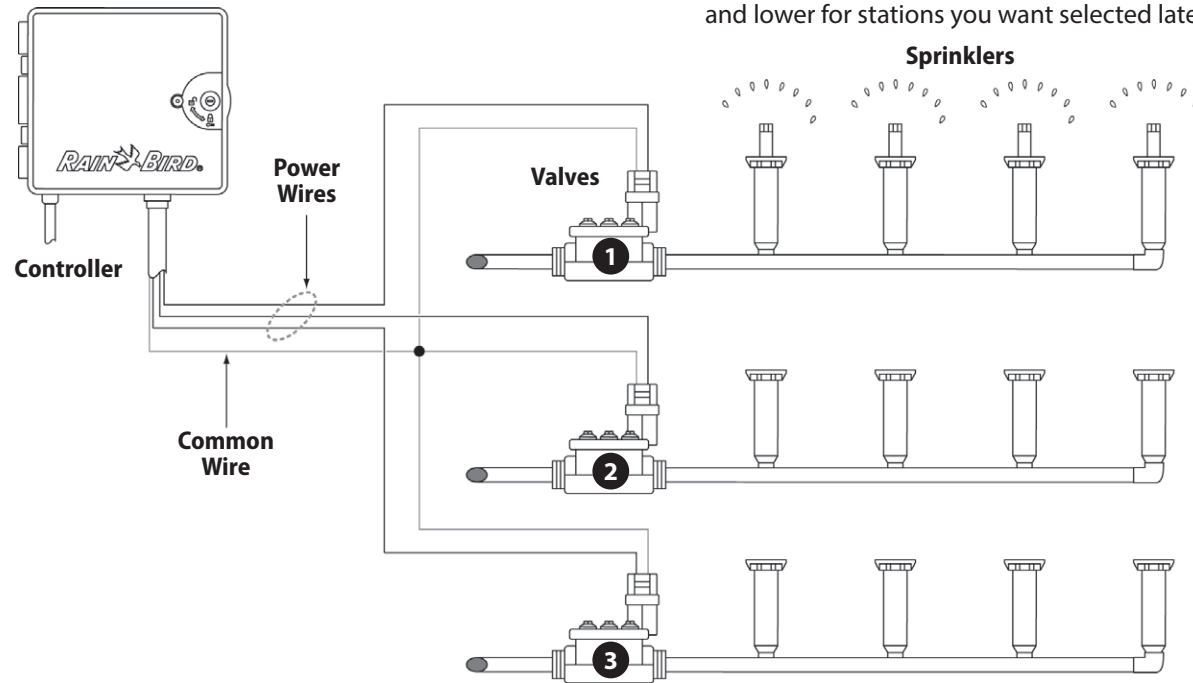

LXME System Wiring Diagram

ESP-LXME Model Variants

Rain Bird offers different variants of the ESP-LXME controller, depending on your irrigation requirements.

Available options include:

Model	Modules Included
ESP8LXME	BM-LXME Base Module ESP-LXM-SM8 Station Module
ESP12LXME	BM-LXME Base Module ESP-LXM-SM12 Station Module
ESP8LXMEF	FSM-LXME Flow Smart Module ESP-LXM-SM8 Station Module
ESP12LXMEF	FSM-LXME Flow Smart Module ESP-LXM-SM12 Station Module

Base Modules

Base Modules install in module slot 0 and provide wiring terminals for multiple controller inputs and outputs including valve common, master valve, weather sensor, and 24 VAC.

BM-LXME Base Module

The BM-LXME Base Module is the standard base module for ESP-LXME Controller models.



FSM-LXME Flow Smart Module

The FSM-LXME Flow Smart Module is the standard base module for ESP-LXMEF Controller models. The FSM-LXME provides the standard Base Module inputs and outputs and also includes a flow sensor input.



NOTE: The Base and Flow Smart Module include a jumper wire connecting the weather sensor (SEN) terminals. Do not remove the jumper wire unless you install a weather sensor. Do not remove the jumper wire unless you install a weather sensor. See Section H, Installation, Connect Local Weather Sensor for more details.

ESPLXM-SM Station Modules

ESPLXM-SM Station Modules install in module slots 1 through 4 and provide wiring terminals for irrigation valves and a valve common.

Each ESP-LXME controller comes standard with either an 8 or 12 station module. This can easily be expanded by adding one to three additional Station Expansion Modules. Each station module adds 4, 8, or 12 additional stations to increase capacity to a maximum of 48 stations. Station Modules can be identified by the blue stripe on the middle of the module.



ESP-LXM-SM8 Station Module



ESP-LXM-SM12 Station Module

Programming Overview

Irrigation Controller Definitions

Programs

The process of telling the controller exactly when and for how long you want to water. The controller opens and closes the remote control valves according to a program you set.

Each program contains:

Watering Days

The days of the week or calendar dates on which irrigation is allowed. For example, specific days such as Monday, Wednesday and Friday could be designated as your “watering days”. Alternatively, the Cyclical watering cycle can be used to water at a regular interval, such as every third day.

Watering Start Time

The time(s) of day that irrigation begins; this is the time that the first station in the program begins watering; all other stations in the program then follow in sequence.

! **NOTE:** The term “start time” refers to the time that a program starts, not to the time that each individual station begins to run.

Station Run Time

The length of time (in hours and minutes) that each individual station is programmed to run.

Programming Chart

Before you begin programming, fill out the Programming Chart. See the Programming Chart instructions for more details.

- 1 Locate the Programming Chart that came with the ESP-LXME controller.



Fill Out Programming Chart

- 2 Follow the instructions to enter information about your system hardware and settings in the appropriate fields on the Programming Chart.

Station #	Description	No. of Valves	Station Flow Rate	Requires MV	Weather Sens
1	ENTRY - SPRAYS	1	52	<input checked="" type="checkbox"/>	<input checked="" type="checkbox"/>
2	ENTRY - COLOR BEDS	2	26	<input type="checkbox"/>	<input type="checkbox"/>

A circled number 2 with two arrows pointing to the 'Requires MV' and 'Weather Sens' columns for station 2.

Storing the Programming Chart

Return the Programming Chart to a permanent, safe location when you're finished working with it. We recommend hanging it on the hook inside the controller cabinet door as shown below.

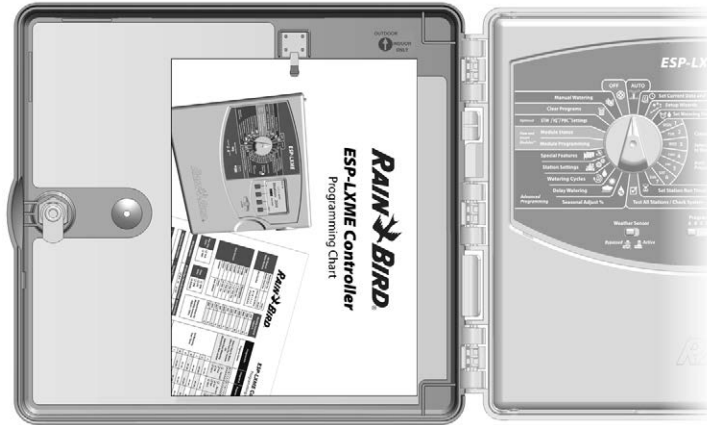

Remote Programming

The ESP-LXME controller front panel can be programmed while operating under battery power.

This feature is useful if the controller is installed in an area that is not easily accessible. It also lets you enter program information before installing the controller at the job site. All program information is stored in nonvolatile memory so it will be preserved indefinitely in the event of a power outage or removal of the battery.

! **NOTE:** Under battery power, all programs in progress will continue to run in the controller memory, but irrigation will not occur until power is restored. Without battery power, programs in progress are cancelled.

1 Install a new 9-volt battery in the battery compartment in the back of the front panel.

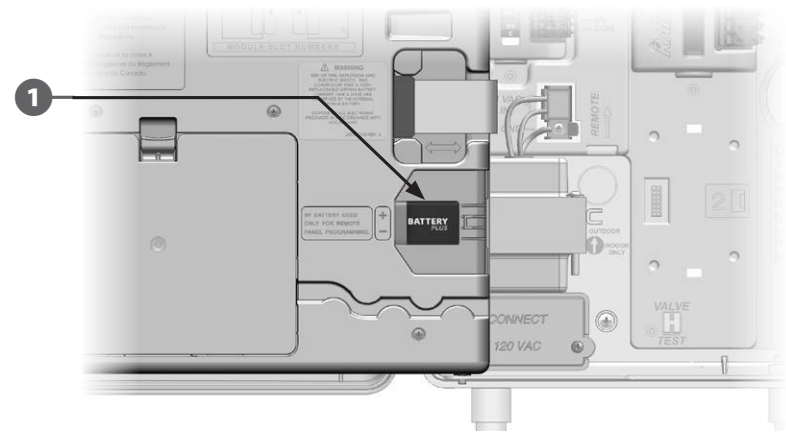

! **NOTE:** To perform remote programming under battery power, detach the front panel from the cabinet. See Access Controller Cabinet in Section H for more details.

⚠ **CAUTION:** The controller can not run irrigation or system diagnostics with the front panel detached. Re-connect the front panel to the controller's AC power source as soon as remote programming is completed.

Programming Checklist

When programming the ESP-LXME controller for the first time, it is recommended that you complete the following steps in order.

For your convenience a check-off box is provided for each step.

Set Up Hardware

- Install SM Station Modules Page 102
- Fill out Programming Chart (see Programming Chart instructions)
- Clear program information..... Page 81
- Set language..... Page 77
- Set date..... Page 14
- Set time..... Page 15
- Set up master valve (optional)..... Page 50
- Set up weather sensor (optional) Page 39
- Set up stations Page 46
- Set up flow sensor with Flow Smart Module (optional) Page 56

Set Up Programs

A B C D

- Select program (A, B, C or D)..... Page 13
- Set watering start times Page 16
- Select watering days * Page 17
- Set station run time(s)..... Page 18

* See Advanced Settings dial position for Odd, Odd31, Even and Cyclical watering cycles.

Set Up Programs (Optional)

- Set seasonal adjust Page 31
- Create a water window Page 36
- Set up a station delay Page 37
- Set up SimulStations Page 43

Review Setup

- Confirm program Page 19
- Test stations Page 25
- Check installed modules Page 49

Optional Setup

- Schedule calendar days off..... Page 35
- Create an MV manual water window Page 86
- Set Cycle+Soak..... Page 48
- Set flow units Page 51
- Activate FloManager Page 52
- Activate FloWatch Page 69
- Set up SEEF and SELF actions Page 60
- Set controller to AUTO Page 9

AUTO

Automatic Operation

The controller will operate automatically with the controller dial set to AUTO.

If you forget to return the dial to AUTO, the controller will automatically continue to run programs, unless the dial is set to the OFF position when all irrigation is canceled.

- ▶ Turn the controller dial to AUTO.

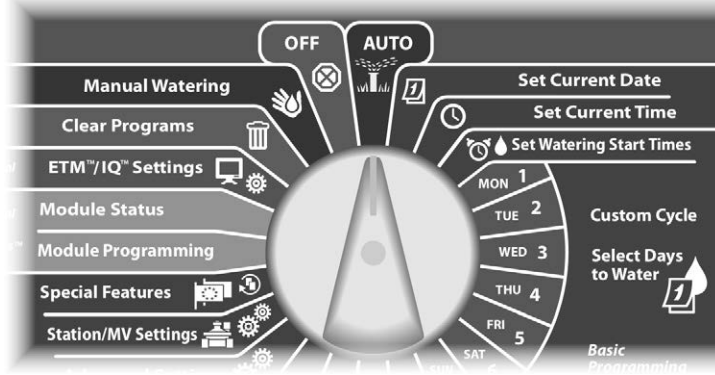

- 1 The Auto screen is displayed with the current day and time shown.
- 2 When a program is running in AUTO mode, the station number will display on the screen. Press the + or - buttons to add or subtract minutes from the run time for the currently running station. To advance to the next station in a program, press the Adv button.

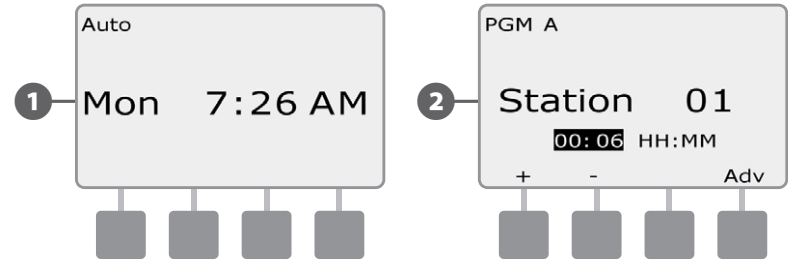

- ▶ To cancel a currently running program, turn the controller dial to OFF for three seconds and then return the dial to AUTO.

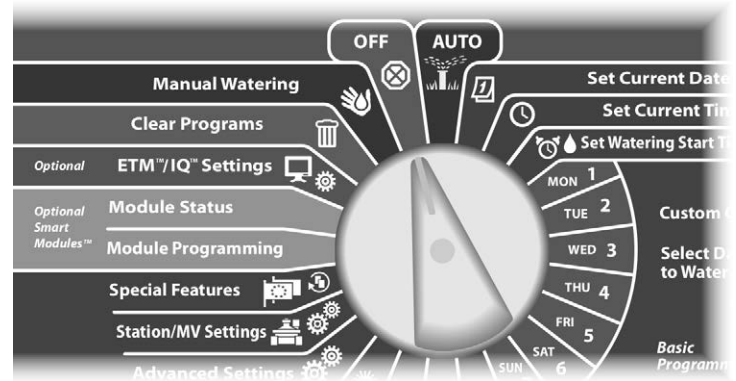

Alarm Conditions

An alarm condition can occur when programming omissions or other issues prevent normal irrigation.

FloWatch™ Alarms

The controller will alarm for certain flow conditions if you have the optional Flow Smart Module installed. See Section E, FloWatch for more details.

Review Alarm Messages

- 1 When an alarm condition is detected, the alarm light on the controller front panel will illuminate.

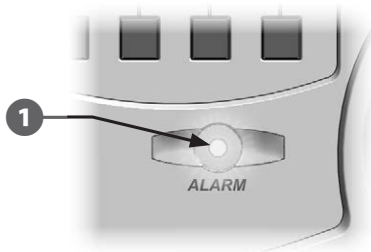

- 2 When an alarm condition is present, the Alarm button label will be present on screen. Press the Alarm button to view alarm details.
- 3 Any current alarm conditions will then be displayed. Press the Next button if necessary, to advance to the next page.

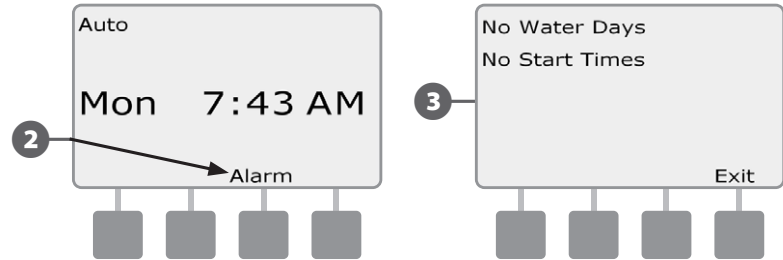

- !** **NOTE:** Take the appropriate action to address each alarm condition. When all alarms have been addressed, the alarm light on the front panel will no longer be illuminated.

- ▶ Turn the controller dial to AUTO.

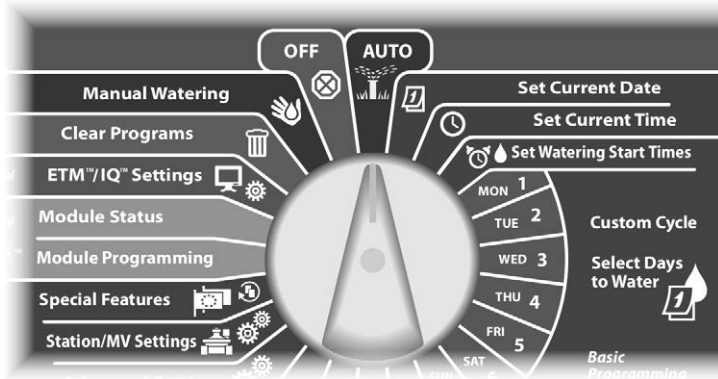

Resetting the Controller

Sometimes you may want to reset (or reboot) the ESP-LXME controller. Using the controller's reset feature does not change or delete the programs you have programmed into the controller.

- 1 Turn the controller dial to AUTO.

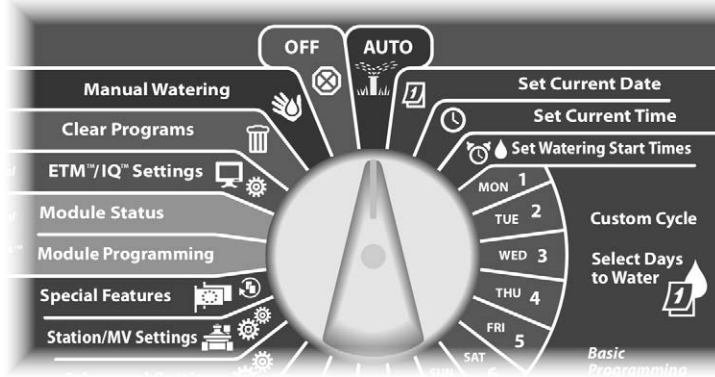

- 2 Open the controller outer cabinet door and inner front panel.
- 3 Locate the RESET button on the back of the front panel.

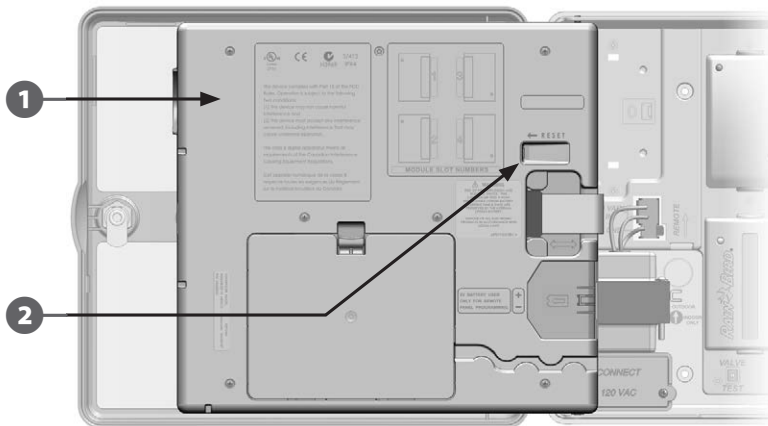

- 4 Use a pen or pencil to depress the RESET button.
- 5 The "Rain Bird" screen appears, confirming reset.



this page intentionally left blank

Section B - Basic Programming

Program Select Switch

Always begin programming by setting the Program Select switch to the desired program.

Four independent Programs, A, B, C and D are available in the ESP-LXME controller. Multiple programs allow you to set watering schedules to meet different requirements for plant materials, soils, slopes, and shady or sunny areas. Programs can operate simultaneously with the only limitation being the number of stations you program to run simultaneously.

Select Program

On the controller front panel, slide the Program Select switch under the A, B, C, or D, then begin programming.

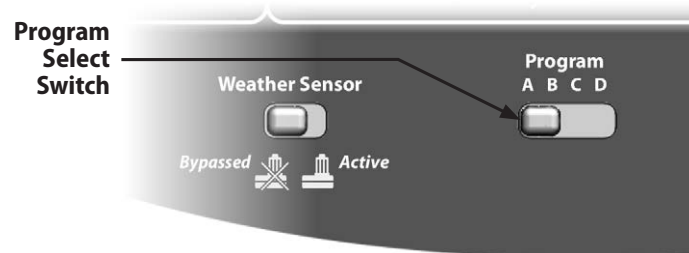

! **NOTE:** When programming the controller, any program-specific information you enter, such as start times or watering days, will affect only the selected program.

Weather Sensor Bypassed/Active Switch

A weather sensor is not required for the ESP-LXME controller, but can increase functionality by allowing you to prevent or pause irrigation based on changing weather conditions.

You can set the controller to ignore or obey input from one supported weather sensor, which connects to the LXME base module via a separate wired or wireless connection. See Section H, Local Weather Sensor for more details.

Bypass or Activate Weather Sensor

On the controller front panel, slide the Weather Sensor switch to Bypassed (to ignore) or Active (to obey).

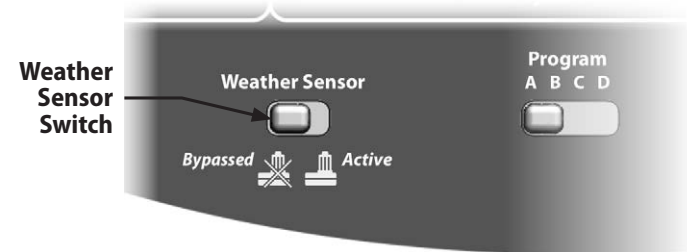

Set Current Date

- Turn the controller dial to Set Current Date.

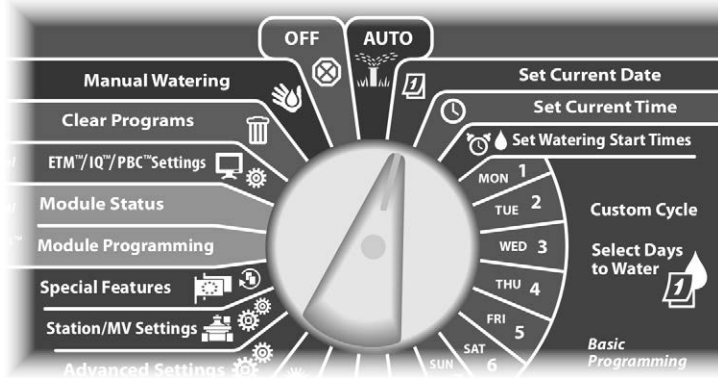

- Press + and – to set the current year.

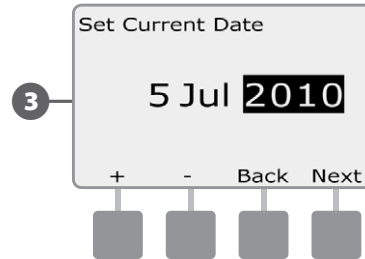

- The Set Current Date screen appears. Press the + and – buttons to set the current day; then press Next.
- Press the + and – buttons to set the current month; then press Next.

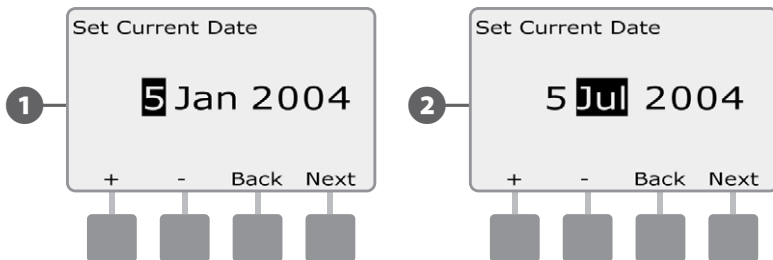

Set Current Time

- Turn the controller dial to Set Current Time.

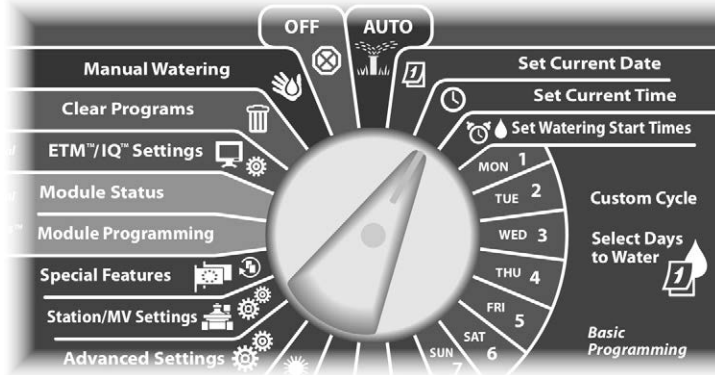

- 1 The Set Current Time screen appears. Press the + and – buttons to set the current hour; then press Next.



NOTE: Be sure to set the hour correctly to either AM or PM.

- Press and HOLD buttons to accelerate settings for hours and minutes.

- 2 Press the + and – buttons to set the current minute; then press Next.

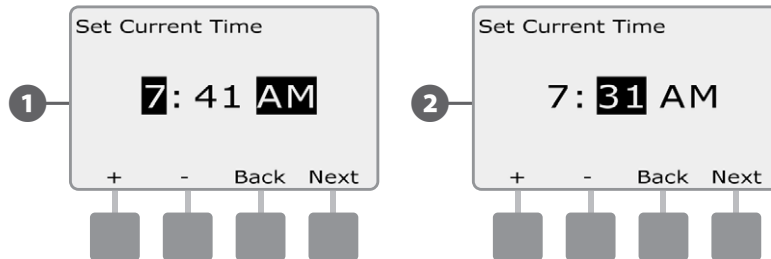

Set Watering Start Times

Start times are the time(s) of day that the program begins.

You can assign up to eight Start Times per day to a single program. Multiple Start Times allow you to run a program more than once on each day. For example, if you're growing new lawn seed, you may want to water several times a day to keep the seedbed or top dressing damp.

NOTE: Start times apply to the entire program and not just to an individual station.

Turn the controller dial to Set Watering Start Times.

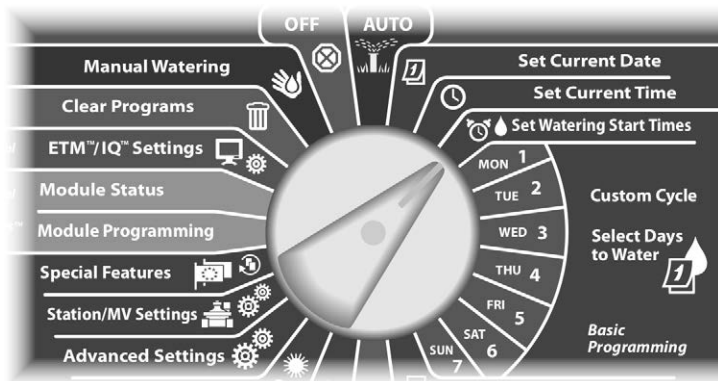

1 The Set Start Times screen appears. Press the + and – buttons on the left to set Start Time for the current program.

- Press and HOLD buttons to accelerate settings for hours and minutes.

NOTE: If the desired program is not selected, use the Program Select switch to change it. See Section B, Program Select Switch for more details.

2 Press the + and – buttons on the right to set the start number (1 through 8).

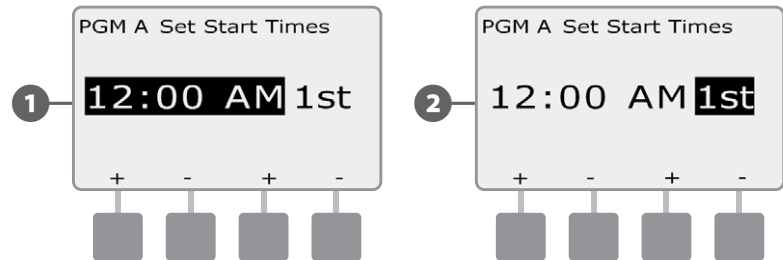

Change the Program Select switch and repeat this process to set up additional Watering Start Times for other programs as desired.

NOTE: Cycle+Soak™ is an alternative method of dividing the total Station Run Time into smaller cycle times. If you plan to use Cycle+Soak, only a single Watering Start Time is required for each program. See Section D, Set Up Cycle+Soak for more details.

Select Days to Water

Watering Days are the specific days of the week on which irrigation programs are allowed to start.

The ESP-LXME controller can be programmed to irrigate on different days, dates and cycles. Regardless of which Watering Cycle you set, the controller will only start the program on the days or dates that you select. For additional information see Watering Cycles later in this section.

NOTE: The selections you make on the day positions of the controller dial will carry over to the Watering Cycles day settings and vice versa.

Turn the controller dial to Mon 1.

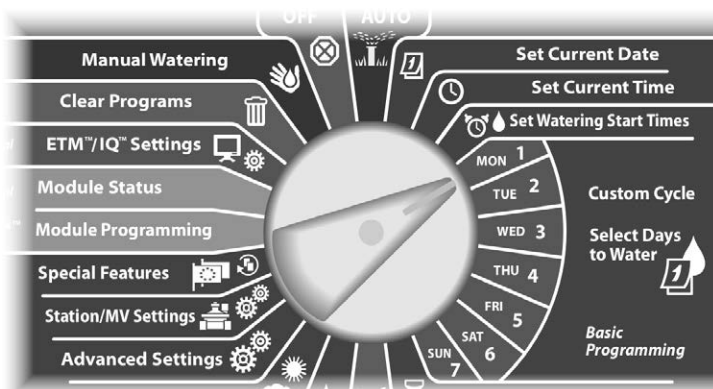

1 The Custom screen appears. Press the Allow or Prevent buttons to choose whether or not to allow irrigation starts to occur for that day of the week.

NOTE: If the desired program is not selected, use the Program Select switch to change it. See Section B, Program Select Switch for more details.

2 Turn the controller dial to Tue 2 and repeat the process.

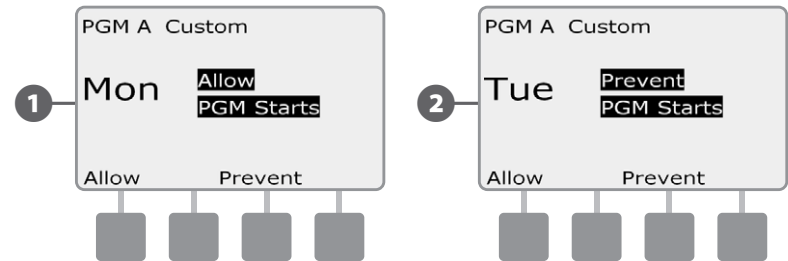

Repeat this process for all other days of the week in the program. Then change the Program Select switch and repeat this process to select Days to Water for other programs as desired.

Station Run Times

Run Times are the number of minutes (or hours and minutes) that each station runs.

Station Run Times are particular to programs; so typically stations are set for a single program.

- ▶ Turn the controller dial to Set Station Run Times.

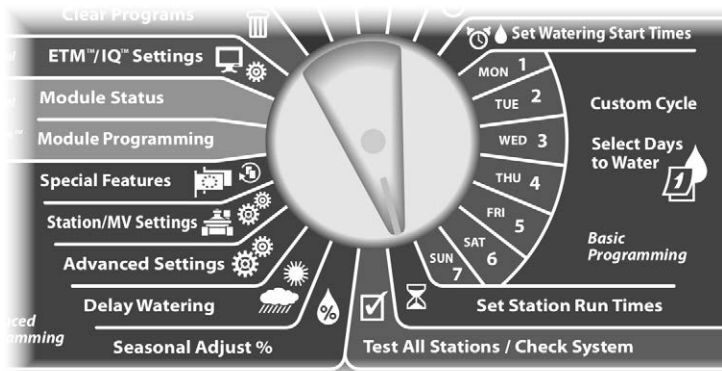

- 1 The Set Run Times screen appears. Press the + and – buttons on the left to select the station to program.

! **NOTE:** If the desired program is not selected, use the Program Select switch to change it. See Section B, Program Select Switch for more details.

- 2 Press the + and – buttons on the right to set the Station Run Time. Range can be from 00 minutes (no Run Time) up to 24:00 hours.

- Press and HOLD buttons to accelerate settings for hours and minutes.



- ↻ Change the Program Select switch and repeat this process to set up additional Station Run Times for other programs as desired.

! **NOTE:** Seasonal Adjust % adjustments will adjust the Station Run Time down to the second. For example, if the Run Time is set for 1 minute and the Seasonal Adjust % is set to 50% then the adjusted Run Time equals 30 seconds.

Section C - System Diagnostics

Test All Stations/Check System

Review and confirm scheduled irrigation Programs, Program Run Times and Station Run Times.

Confirm Programs

The ESP-LXME controller can make calculations and provide feedback on Start Times and total Run Times for programs and stations.

Program Summary

Review program information for all programs:

- Turn the controller dial to Test All Stations/Check System.

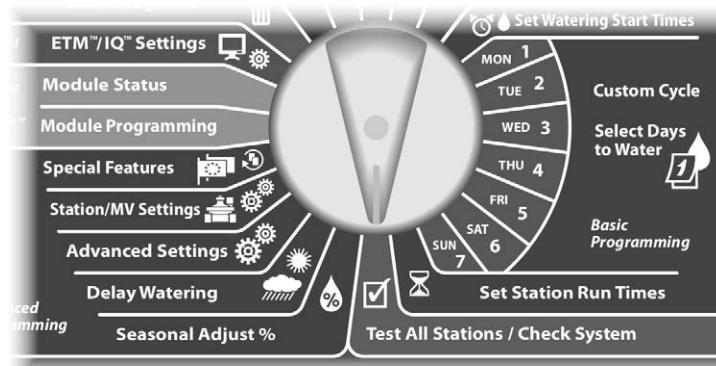

- The Check System screen appears with Confirm Programs selected; press Next.
- The Confirm Programs screen appears with Program Summary selected; press Next.

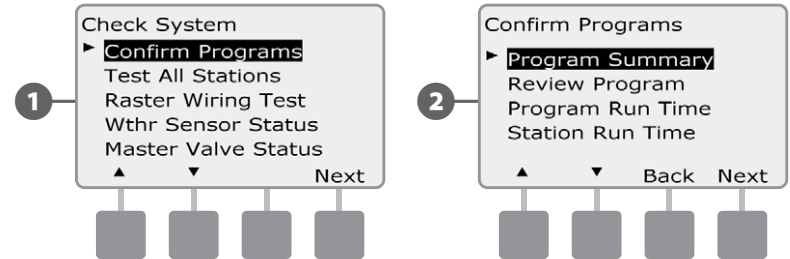

- The Program Summary screen appears, providing a summary of Run Times, Start Times and Water Days for all programs.

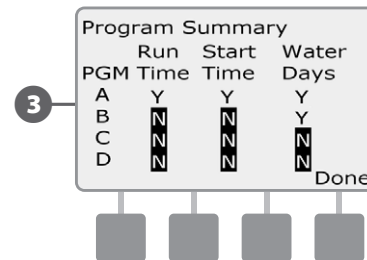

- NOTE:** In the above example, Program A will run because it has Station Run Times, Start Times and Water Days all programmed, as indicated by the "Y" in each column for PGM A.

Program B however will not run as it is missing both the Run Time and Start Time, as indicated by the "N" in each of those columns for PGM B.

Review Program

Review program information for a station:

- Turn the controller dial to Test All Stations/Check System.

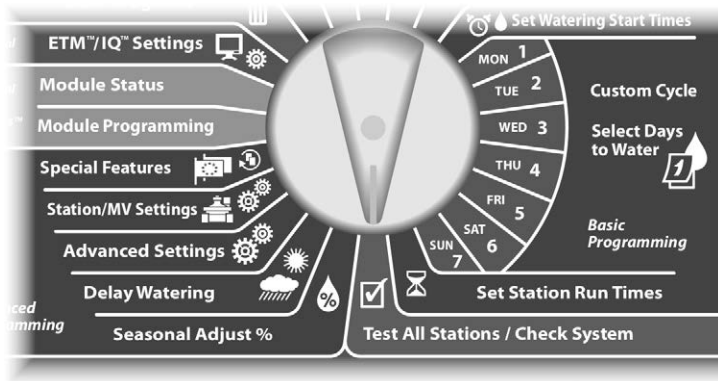

- The Check System screen appears with Confirm Programs selected; press Next.
- The Confirm Programs screen appears. Press the Down Arrow button to select Review Program; then press Next.

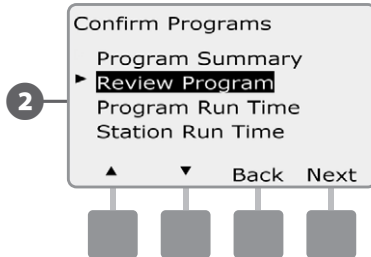
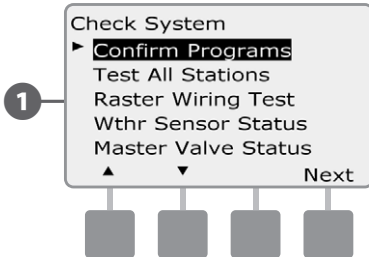

- The Watering Start Times review screen appears with start times displayed for the currently selected program. Press Next.

NOTE: If the desired program is not selected, use the Program Select switch to change it. See Section B, Program Select Switch for more details.

- The Watering Day Cycle review screen appears with the current watering day cycle displayed. Press Next.

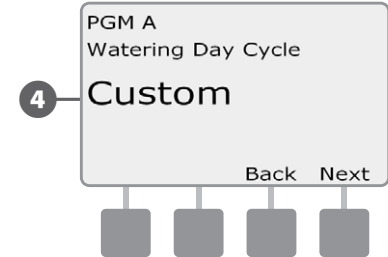
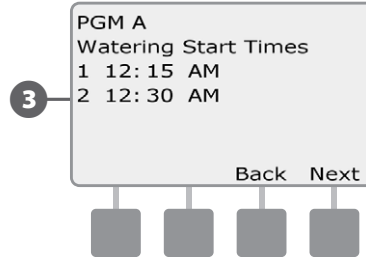

- The Watering Days review screen appears with allowed watering days displayed. Press Next.

- The Run Times review screen appears with run times for each station displayed. Press Next.

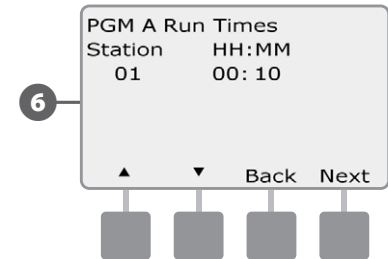
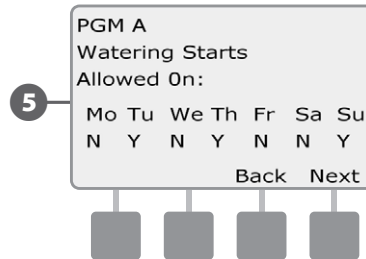

- 7 The Seasonal Adjust review screen appears with seasonal adjustment percentage displayed. Press Next.
- 8 The Seasonal Adjust by Month review screen appears with seasonal adjustment percentage displayed for the first allowed month. Press the + and - buttons to see Seasonal Adjust percentage for other months as desired; then press Next.

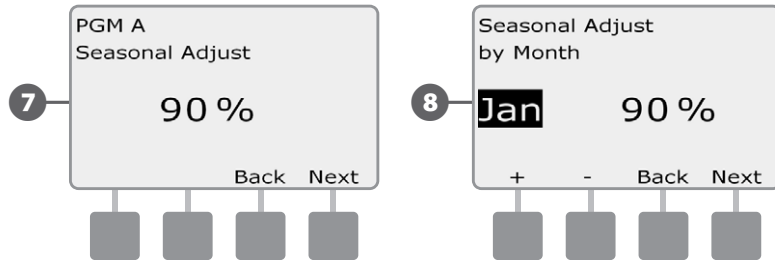

- 9 The Rain Delay review screen appears with number of days remaining until next watering date displayed. Press Next.
- 10 The Calendar Day Off review screen appears with all selected calendar days off displayed. Press Next.

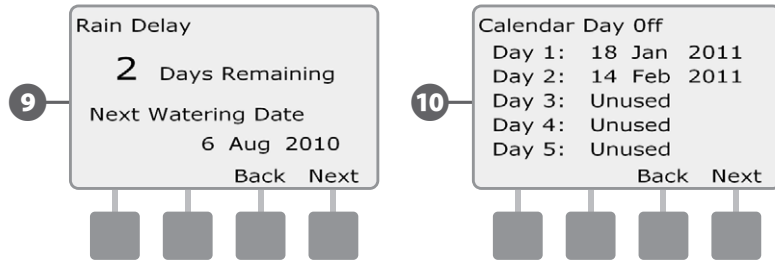

- 11 The Station Delay review screen appears with delay time between stations displayed. Press Next.
- 12 The Cycle+Soak Minutes review screen appears with the Cycle+Soak times for each station displayed. Press Next.

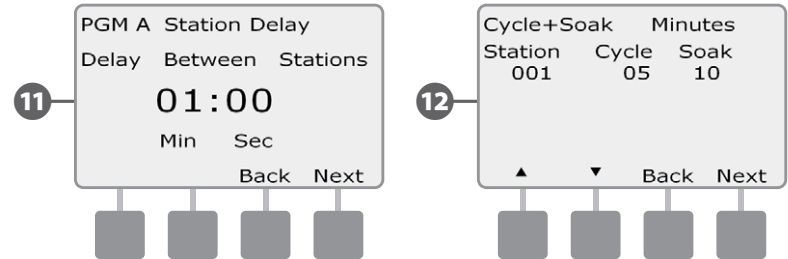

- 13 The Master Valve Assignment review screen appears with MV information displayed. Press Next.
- 14 The Weather Sensor Assignment review screen appears with stations that use sensor override displayed. Press Next.

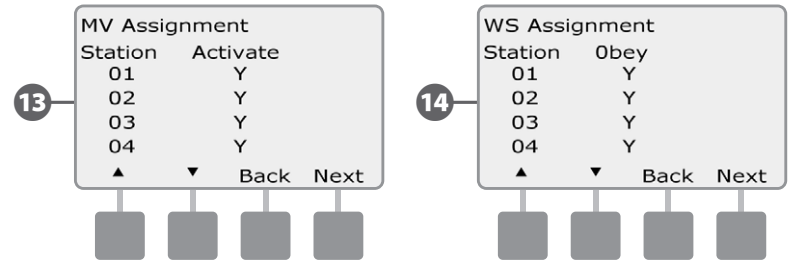

15 The Water Window review screen appears with water window open time, close time and duration displayed. Press Next.

16 The Maximum Number of SimulStations for program review screen appears with the maximum number of stations that can operate simultaneously for that program are displayed. Press Next.

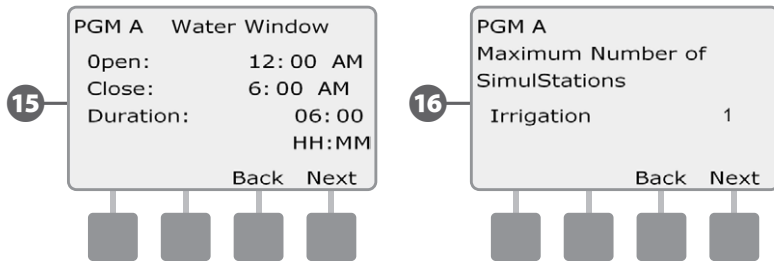

17 The Maximum Number of SimulStations for controller review screen appears with the maximum number of stations that can operate simultaneously for that controller are displayed. Press Next.

18 The Backup Programs review screen appears with the Contractor Default backup program status displayed. Press Next.

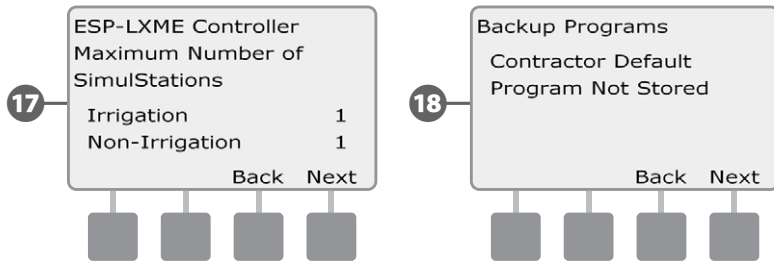

Program Run Time

Review total Run Time for an individual program:

- 1 Turn the controller dial to Test All Stations/Check System.

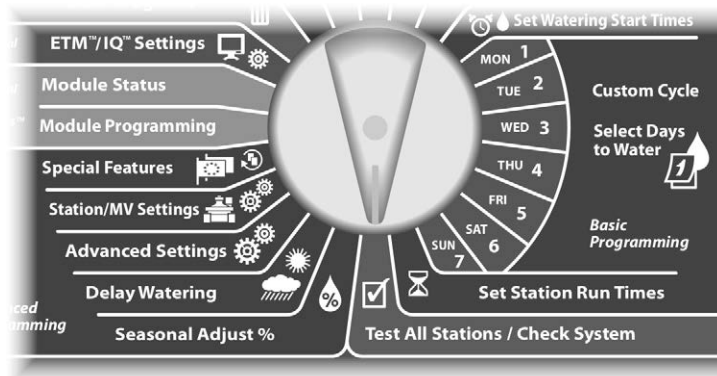

- 1 The Check System screen appears with Confirm Programs selected; press Next.
- 2 The Confirm Programs screen appears. Press the Down Arrow button to select Program Run Time; then press Next.

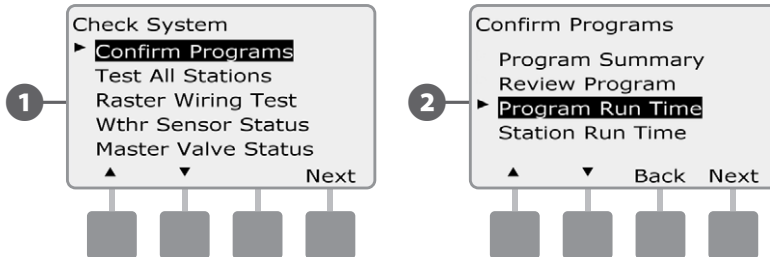

- 3 The Total Run Time screen appears and total Run Time is displayed for the currently selected program.

- ! **NOTE:** If the desired program is not selected, use the Program Select switch to change it. See Section B, Program Select Switch for more details.

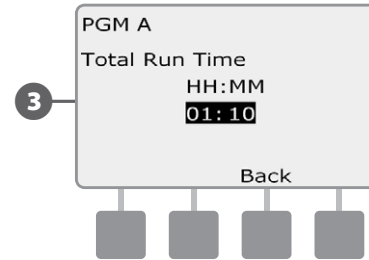

- ! **NOTE:** For stations set up for Cycle+Soak, the Cycle Time (when irrigation is occurring) will be included in Program Run Time calculations but Soak times will NOT be included. See Section D, Set Up Cycle+Soak, for more details.

- ! **NOTE:** The total program run time is the cumulative total run time if stations are run one at a time. If SimulStations have been set to more than 1, total irrigation time will be less.

- ↻ Change the Program Select switch and repeat this process to review and confirm Program Run Times for other programs as desired.

Station Run Time

Review total Run Time for all stations:

- Turn the controller dial to Test All Stations/Check System.

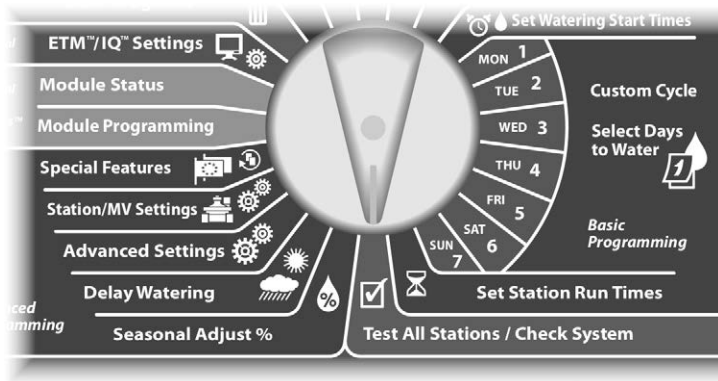

- The Check System screen appears with Confirm Programs selected; press Next.
- The Confirm Programs screen appears. Press the Down Arrow button to select Station Run Time; then press Next.

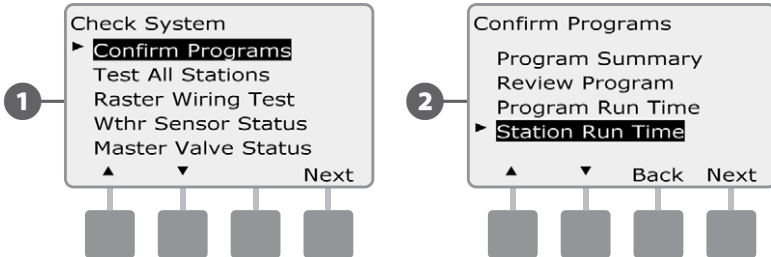

- The Sta Run Time Per Day screen appears with total Run Time displayed for the currently selected station in all four programs. For programs where a particular station is not used no runtime will show.

- Press the + and – buttons to advance and see additional stations.

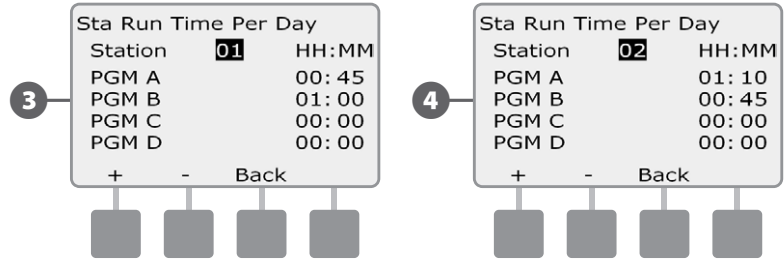

- NOTE:** Soak times for stations set up with Cycle+Soak are not included in the Station Run Time calculations. See Section D, Set Up Cycle+Soak for more details.

Test All Stations

You can test all stations connected to your controller by running each of them in station number sequence.

Sometimes this is useful after installation, for general maintenance or as a first step in troubleshooting your system.

NOTE: Only stations with programmed run times are included in the Test All Stations operation.

Turn the controller dial to Test All Stations/Check System.

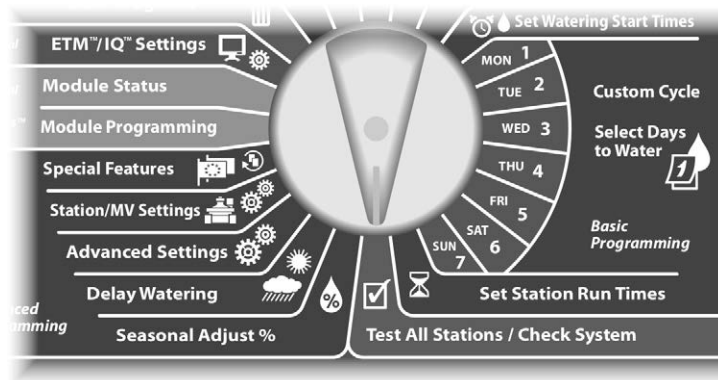

1 The Check System screen appears. Press the Down Arrow button to select Test All Stations; then press Next.

2 The Test All Stations screen appears. Press the + and – buttons to adjust the Test Run Time (adjustable from 1 to 10 minutes) per station; then press Run.

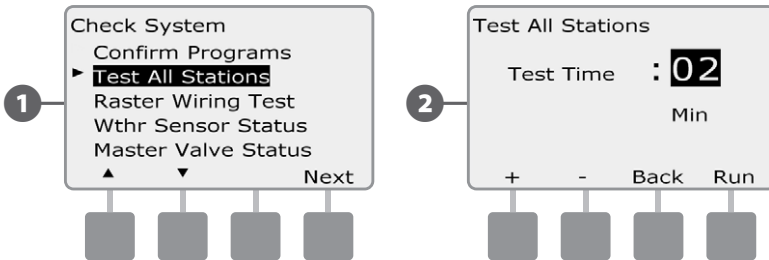

3 A confirmation screen appears.

4 Once Run is pressed, stations can be monitored and advanced by turning the dial to the AUTO position and using the Adv button. Press the + and – buttons to increase or decrease Run Time minutes for the current station.

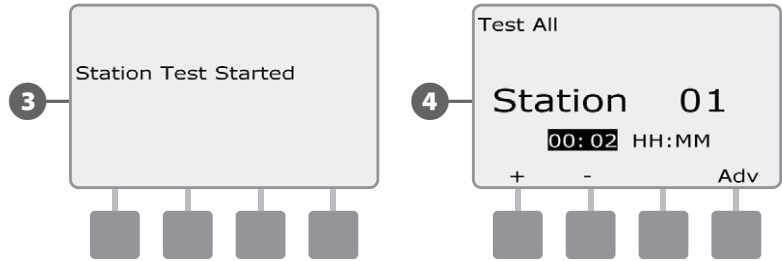

Wiring Diagnostics

Although finding the exact location of issues in the field often requires some amount of in-the-field troubleshooting, the controller has some built-in features to help you narrow down the possible issues.

Before beginning diagnostics, it may be helpful to take the following steps to eliminate possible other causes:

1. Review and Confirm Programs to check station priorities.

If a suspect station isn't watering as scheduled, the underlying issue could be programming-related. The ESP-LXME controller can be configured to operate stations in order of station number or station priority. If Station Sequencing by Station Priority mode is enabled and multiple programs are running, higher priority stations will irrigate prior to medium priority stations, and medium priority stations will irrigate prior to lower priority stations. See Confirm Programs in this section for more details.

2. Run a Test All Stations check to ensure valves are working properly.

The Test All Stations manual test will take priority above pre-programmed irrigation and allow you to determine which stations are working properly. See Test All Stations for more details.

Raster Wiring Test

The ESP-LXME controller can quickly test to determine if any stations have shorted or open wires or valve solenoids.

▶ Turn the controller dial to Test All Stations/Check System.

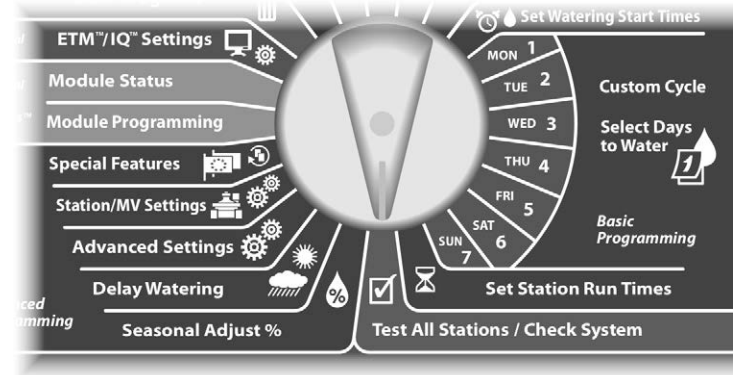

- 1 The Check System screen appears. Press the Down Arrow button to select Raster Wiring Test; then press Next.
- 2 The Raster Wiring Test screen appears. The test begins automatically.

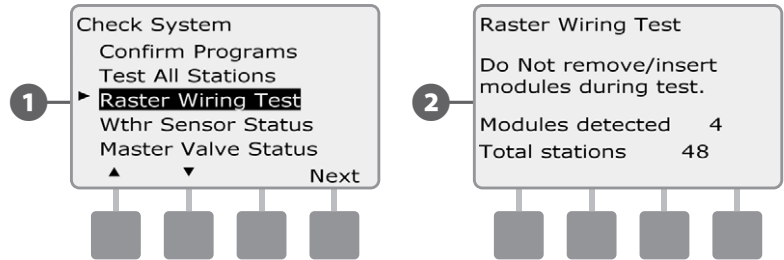

! **NOTE:** During the test every installed station number is briefly displayed on the screen.

- 3 When the test is complete, the results are displayed on the screen. Press the + and - buttons to scroll through all stations that have short circuits or open circuits.

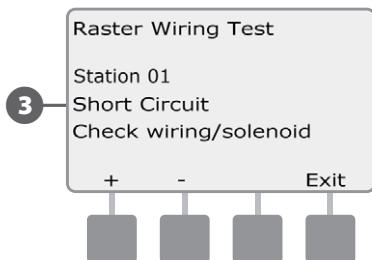

Weather Sensor Status

- Turn the controller dial to Test All Stations/Check System.

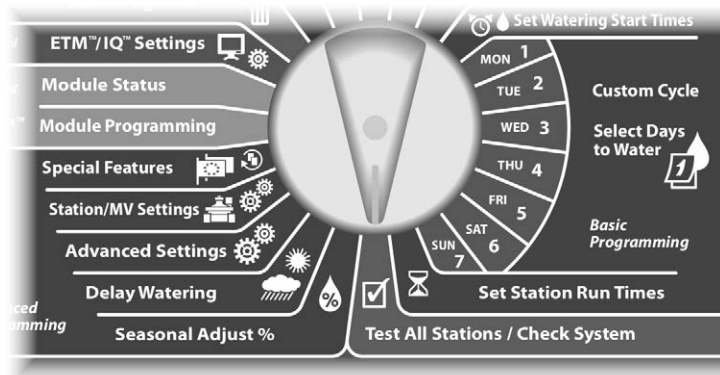

- The Check System screen appears. Press the Down Arrow button to select Wthr Sensor Status; then press Next.
- The Weather Sensor Status screen appears, showing the status of the installed weather sensor.

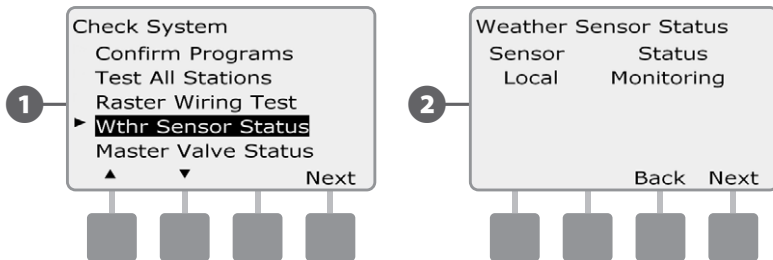

The sensor will display one of five status conditions:

- Monitoring - sensor is active monitoring current weather conditions.
- <Inactive> installation has not been completed or the sensor is not linked to any stations.
- PAUSING - current weather condition has caused the sensor to pause irrigation.
- PREVENTING - current weather condition has caused the sensor to prevent irrigation.
- BYPASSED - sensor switch is in the Bypassed position and the sensor is not monitoring current weather conditions.



NOTE: If current weather conditions are sufficient for the weather sensor to prevent or pause irrigation, then a message appears on the Auto screen. This is not considered an alarm, so the controller alarm light will not illuminate.

Master Valve Status

- Turn the controller dial to Test All Stations/Check System.

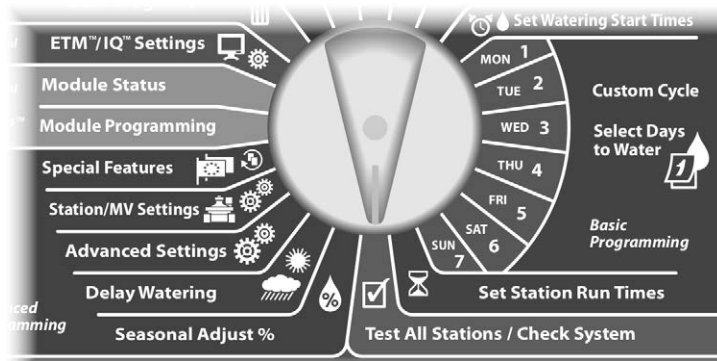

- The Check System screen appears. Press the Down Arrow button to select Master Valve Status; then press Next.
- The MV Status screen appears, showing the status of the installed master valve.

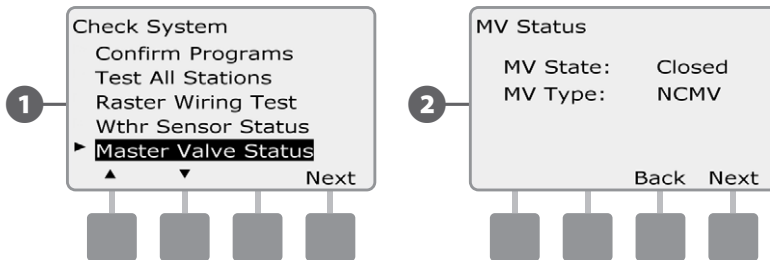

this page intentionally left blank

Section D - Advanced Programming

The ESP-LXME controller has a wide variety of advanced but easy-to-use features designed to simplify irrigation.

Seasonal Adjust %

Seasonal Adjust % allows you to use the heaviest irrigation season as a baseline and adjust to lesser amounts of watering at other times of the year. For example, you could set July at 100% and set October to 50% so there would be half as much watering in Fall than in Summer. Seasonal adjustments can be managed by month or by program.

CAUTION: Multiple Seasonal Adjustment settings affect each other and can significantly impact irrigation. For example, if you set a program-level Seasonal Adjustment of 10% and then a monthly Seasonal Adjustment of 10%, irrigation will be reduced to 1% of normal (10% of 10%). Consider using only one type of Seasonal Adjustment setting.

CAUTION: Setting a small number for the Seasonal Adjustment percentage will greatly reduce watering and setting to 0% will cancel irrigation entirely. Use caution when making Seasonal Adjustment settings.

NOTE: Do not use Seasonal Adjustments if you're already using an ET Manager Cartridge (ETC-LX) with your controller. The ETC-LX automatically manages Seasonal Adjustments. For more information consult the Rain Bird web site or the ETC-LX user documentation.

Adjust Individual Program

Turn the controller dial to Seasonal Adjust %.

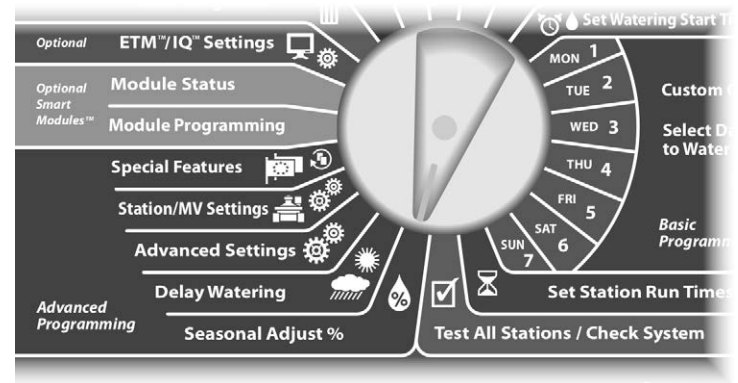

1 The Seasonal Adjust screen appears with Individual PGM selected; press Next.

2 Press the + and – buttons to set the seasonal adjustment percentage (from 0 - 300%).

- Press and HOLD buttons to accelerate settings for percentages.

NOTE: If the desired program is not selected, use the Program Select switch to change it. See Section B, Program Select Switch for more details.

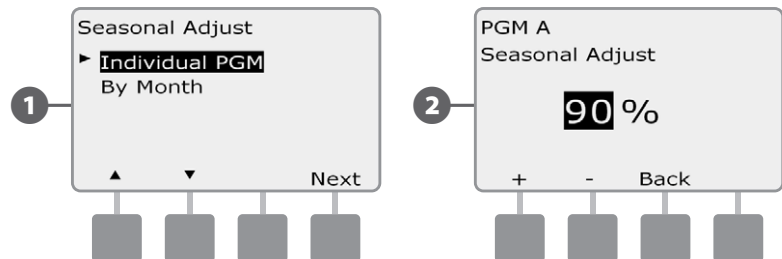

Change the Program Select switch and repeat this process to set Seasonal Adjustments for other programs as desired.

Adjust By Month

Select Months to Adjust

- Turn the controller dial to Seasonal Adjust %.

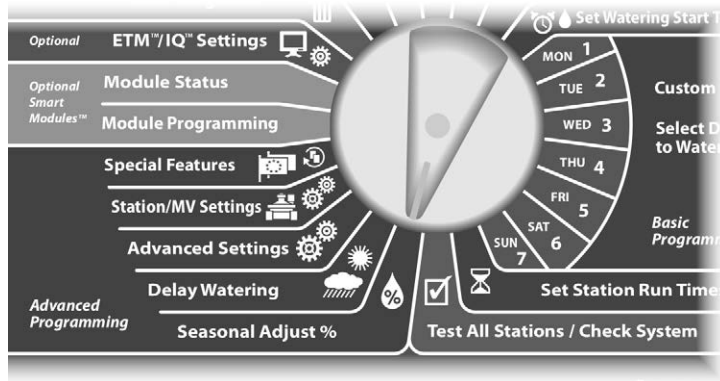

- The Seasonal Adjust screen appears. Press the Down Arrow button to select By Month; then press Next.
- The Seasonal Adjust by Month screen appears with % Adjust selected; press Next.

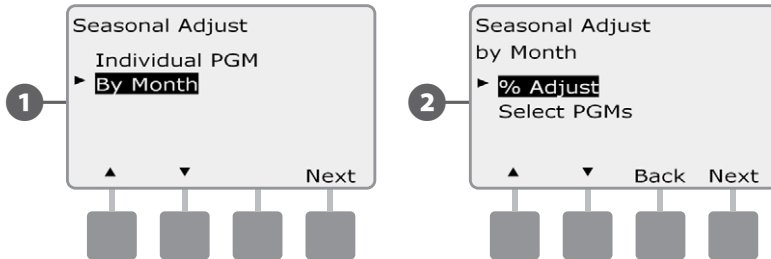

- Press the + and – buttons on the left to select the month you would like to adjust.
- Press the + and – buttons on the right to set the Seasonal Adjustment percentage (from 0 - 300%).
 - Press and HOLD buttons to accelerate settings for percentages.

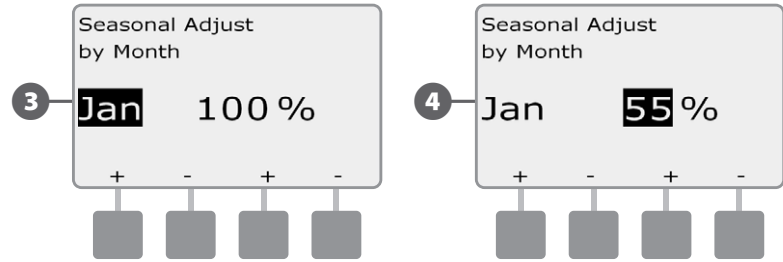

- Repeat this process to set Seasonal Adjustments for other months as desired. Then change the Program Select switch and repeat this process to set Seasonal Adjustments By Month for other programs as desired.

NOTE: The % Adjust will automatically change to the new month's percentage setting on the first day of the month.

Select Programs To Adjust

- Turn the controller dial to Seasonal Adjust %.

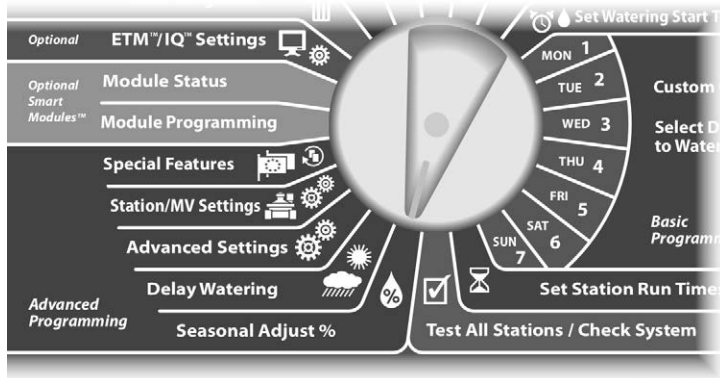

- The Seasonal Adjust screen appears. Press the Down Arrow button to select By Month; then press Next.
- The Seasonal Adjust by Month screen appears. Press the Down Arrow button to select Select PGMs; then press Next.

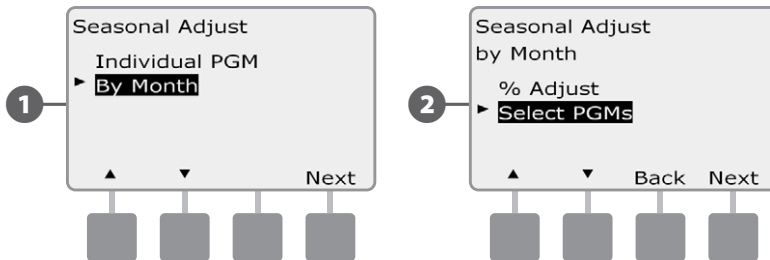

- Press the Yes or No buttons to set Monthly Adjust for the current selected program.
- To set another program, change the Program Select switch to the desired program; a confirmation appears.

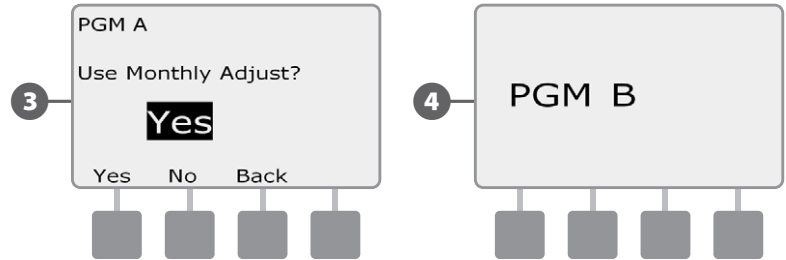

- Repeat this process to set Monthly Adjustments for other programs as desired.

Delay Watering

Rain Delay

The ESP-LXME controller's Rain Delay feature lets you discontinue irrigation for a few days after a period of heavy rain.

The ESP-LXME can also be equipped with an optional Rain Bird ET Manager Cartridge to automatically calculate and automate rain shutdown. Ask your Rain Bird distributor for more details or visit the Rain Bird web site, www.rainbird.com.

NOTE: If you have a rain sensor attached to your controller, it may be unnecessary to manually program a Rain Delay. Consult the rain sensor device documentation for more details.

Turn the controller dial to Delay Watering.

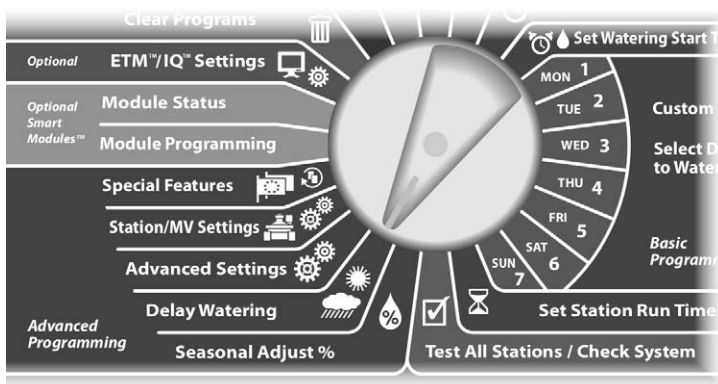

- 1 The Delay Watering screen appears with Rain Delay selected; press Next.
- 2 The Rain Delay screen appears. Press the + and – buttons to set the number of days (from 0 to 14 days) for the Rain Delay. The next irrigation date after the Rain Delay calculates and displays automatically.

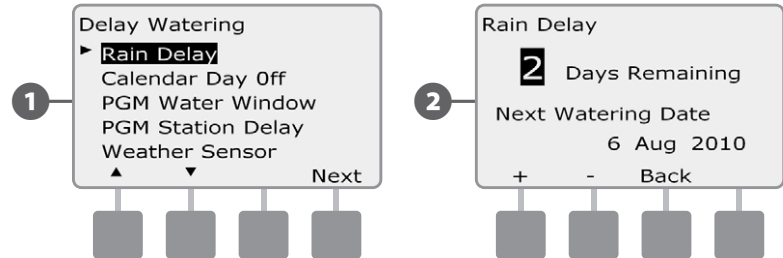

NOTE: A Rain Delay affects all programs, but stations set up as Non-irrigation will still run during a Rain Delay.

Calendar Day Off

You can schedule certain days of the year as Non-irrigation, such as holidays when landscape may receive heavy use.

The ESP-LXME controller can be programmed to suspend irrigation on a particular calendar date, up to 5 different days of the year.

NOTE: Calendar Day Off dates can only be selected 365 days in advance. Then once a Calendar Day Off has passed, it will be removed from the list and must be reprogrammed for the following year if desired.

Turn the controller dial to Delay Watering.

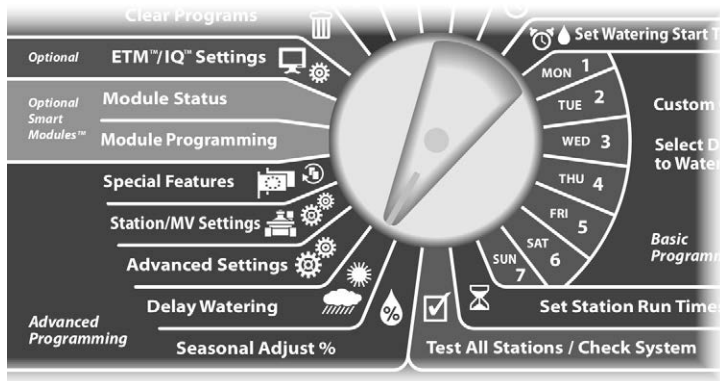

- 1 The Delay Watering screen appears. Press the Down Arrow button to select Calendar Day Off; then press Next.
- 2 The Calendar Day off screen appears, showing (up to 5) scheduled calendar days off in chronological order. Unprogrammed days will show as Unused.

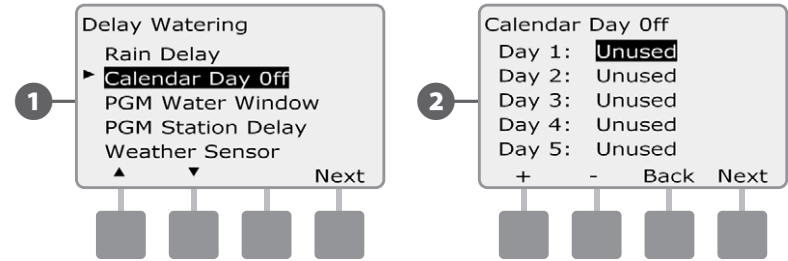

- 3 Press the + and – buttons to set the Calendar Day Off date as desired. Press the Next and Back buttons to select other days as desired.
 - Press and HOLD buttons to accelerate settings for dates.

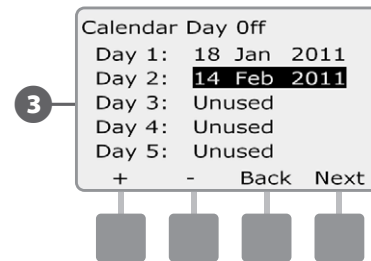

NOTE: Calendar Day Off affects ALL programs and stations, including non-irrigation stations. Consider not using this feature if any of your programs include essential functions such as door locks or sports field lighting.

Water Windows

Used to specify certain times of the day/night when irrigation is allowed.

Otherwise watering is not allowed outside these “Water Windows”. This is helpful to comply with local regulations which may prohibit irrigation during certain hours.

CAUTION: Be sure a Water Window is sufficient to allow irrigation programs to run completely. Irrigation scheduled outside the Water Window will not run but will resume when the Water Window opens again. This can cause irrigation programs to “stack” and eventually create an alarm condition if the controller stacks 8 or more programs.

NOTE: Water Windows can be scheduled to cross midnight. For example, a Water Window can start at 10:00 PM and continue until 4:00 AM the next morning. Be sure your Watering Start Times are set to occur within the Water Window. See Section B, Set Watering Start Times for more details.

Turn the controller dial to Delay Watering.

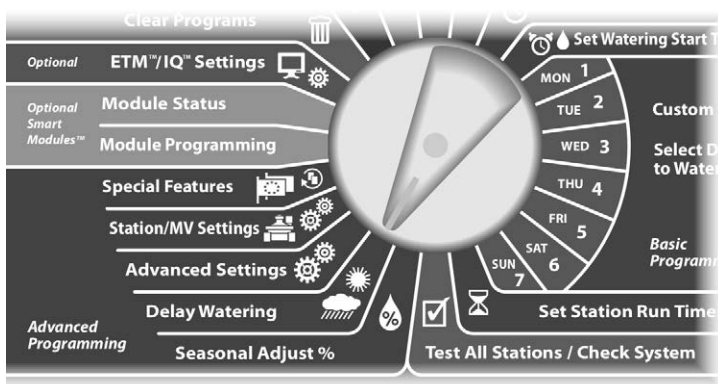

- 1 The Delay Watering screen appears. Press the Down Arrow button to select PGM Water Window; then press Next.
- 2 The Water Window screen appears. Press the + and – buttons to set the time when the Watering Window opens; then press Next.
 - Press and HOLD buttons to accelerate settings for hours and minutes.

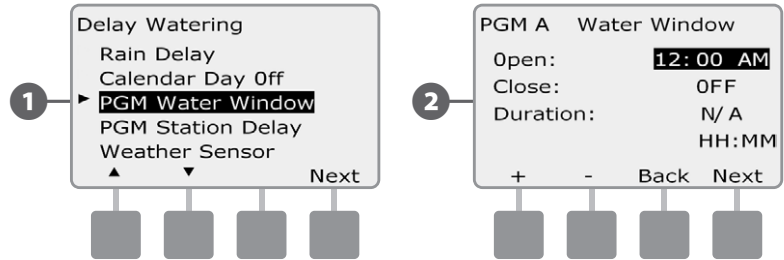

- 3 Press the + and – buttons to set the time when the Watering Window closes. As you adjust the close time, the duration of your Water Window calculates automatically.

NOTE: To clear a previously set Water Window, press the + and – buttons to set both the Open and Close times to OFF (between 11:59 and 12:00 AM).

- 4 To set another program, change the Program Select switch to the desired program; a confirmation appears.

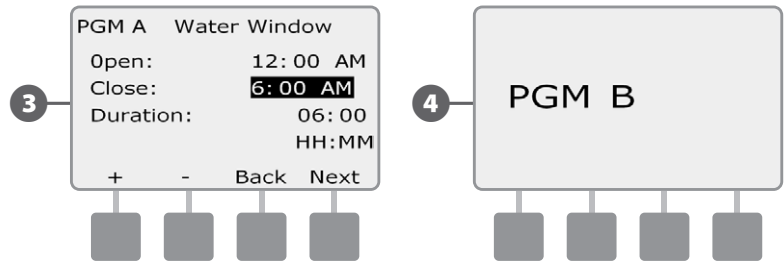

Repeat this process to set or clear Water Windows for other programs as desired.

Station Delay

The ESP-LXME controller can be programmed to include a delay between stations.

This feature delays the start of the next sequential station in a program after the previous station completes.

 **CAUTION:** Consider using short Station Delay times, particularly if your watering schedule or Water Window is short. Long delay times could prevent scheduled irrigation from completing prior to the end of the Water Window. See previous Water Windows for more details.

 Turn the controller dial to Delay Watering.





1 The Delay Watering screen appears. Press the Down Arrow button to select PGM Station Delay; then press Next.

2 The Station Delay screen appears. Press the + and – buttons to set the delay time (from 00:01 second to 10:00 minutes). To clear Station Delay on that station, set to 00:00; then press Next.

- Press and HOLD buttons to accelerate settings for minutes and seconds.

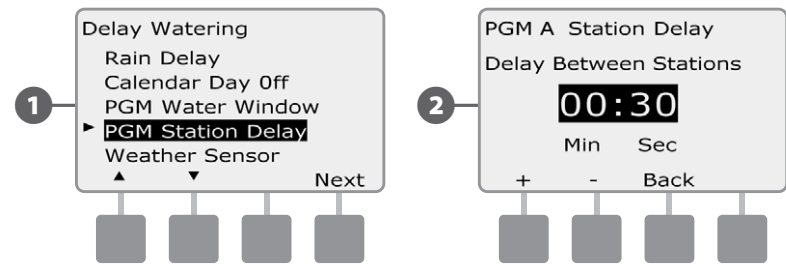
 **NOTE:** If the desired program is not selected, use the Program Select switch to change it. See Section B, Program Select Switch for more details.



 Change the Program Select switch and repeat this process to set Station Delay for other programs as desired.

Weather Sensor

A weather sensor is not required for the ESP-LXME controller, but it can increase functionality by allowing you to prevent or pause irrigation based on changing weather conditions.

The ESP-LXME supports one local weather sensor, via a wireless or wired connection to the LXME Controller base module.

Local Weather Sensor Types

Five types of local weather sensors are supported:

Sensor Types	
Type	Action
Rain	Prevent
Wind	Pause
Freeze	Pause
Soil Moisture	Prevent
Custom Pause	Pause
Custom Prevent	Prevent

Custom Pause Sensors

When a weather condition becomes true, a Custom Pause sensor will stop irrigation and also stop the irrigation timer. When the condition becomes false again, irrigation will start exactly where it left off. For example, if a station is set to irrigate for 20 minutes but is shut down by a Pause sensor after only 5 minutes; when the weather condition becomes false again and after Resume, that station will receive the full remaining 15 minutes of irrigation left on the timer.

Custom Prevent Sensors

When a weather condition becomes true, a Custom Prevent sensor will stop irrigation but allow the irrigation timer to continue to run. When the condition becomes false again, irrigation will resume at the same time had the weather condition never occurred. For example, if a station is set to irrigate for 20 minutes but is shut down by a Prevent sensor after only 5 minutes, if the condition becomes false again after 10 minutes then that station will only receive the remaining 5 minutes of irrigation left on the timer.

Weather Sensor Setup

- Turn the controller dial to Delay Watering.

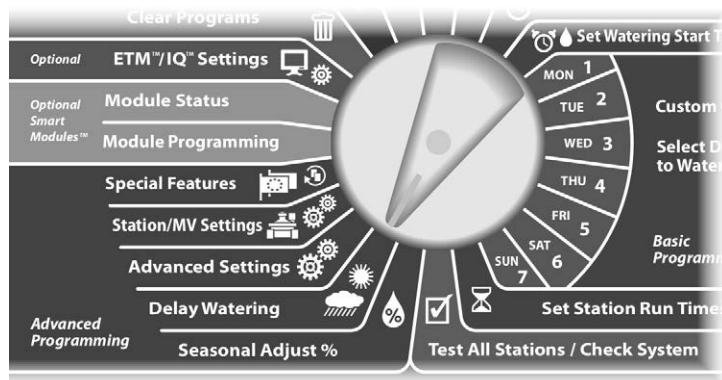

- 1 The Delay Watering screen appears. Press the Down Arrow button to select Weather Sensor; then press Next.
- 2 The Weather Sensor Setup screen appears. Press the + and - buttons to set the weather sensor type; then press Next.

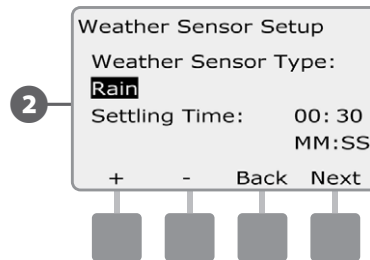
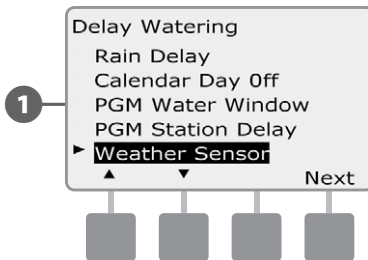

- 3 Press the + and - buttons to set the Settling Time; then press Next.

NOTE: Settling time is how long a weather condition must last before the controller takes action. For example, if a freeze sensor has a 5 minute settling time then the temperature would have to remain below the sensor's threshold set point for 5 minutes before irrigation is paused. Settling time can be set for immediate (0 seconds) or up to 10 minutes long.

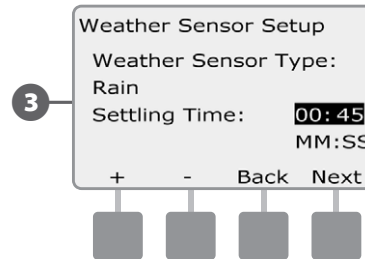

NOTE: The weather sensor is turned on (Active) or off (Bypassed) using the Weather Sensor switch on the controller front panel.

Advanced Settings

Watering Day Cycles

The ESP-LXME controller supports a variety of flexible watering day cycle options.

Watering Cycle Definitions

- ◆ **Custom Days:** irrigation starts on selected days of the week.
- ◆ **Odd Dates:** irrigation starts on all odd numbered calendar days, such as the 1st, 3rd, 5th, etc.
- ◆ **Odd Dates no 31st:** irrigation starts on all odd numbered calendar days, such as the 1st, 3rd, 5th, etc., but not on the 31st.
- ◆ **Even Dates:** irrigation starts on all even numbered calendar days, such as the 2nd, 4th, 6th, etc.
- ◆ **Cyclical Dates:** irrigation starts at regular chosen intervals such as every 3rd or 5th day, regardless of the calendar date.

CAUTION: Regardless of the Watering Cycle, irrigation will start only on days of the week where program starts are allowed. See Section B, Select Days to Water for more details. It's important to select allowed irrigation days carefully to avoid landscape damage in case irrigation delays are lengthy.

NOTE: A watering cycle is selected as soon as it is highlighted with the cursor.

Custom, Odd, Odd no 31st, Even

The process for setting up Custom, Odd, Odd no 31st, and Even Watering Cycles is very similar.

Turn the controller dial to Advanced Settings.

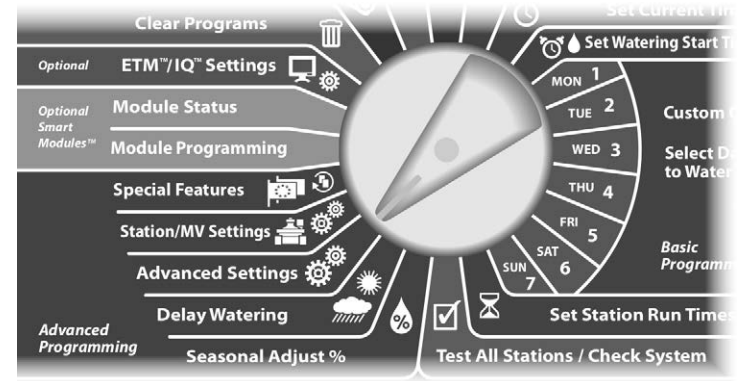

1 The Advanced Settings screen appears with Watering Day Cycles selected; press Next.

2 The Watering Cycle screen appears. Press the Down Arrow button to select Custom Days/Week.

NOTE: If the desired program is not selected, use the Program Select switch to change it. See Section B, Program Select Switch for more details.

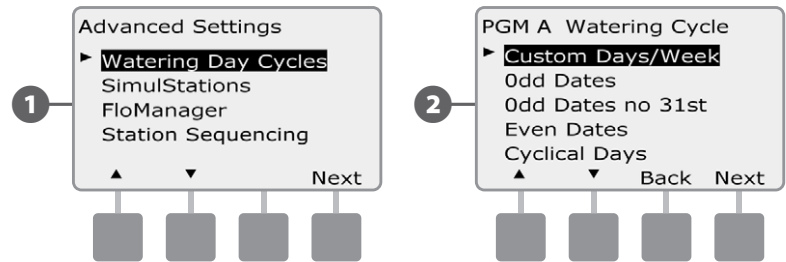

- 3 The Custom screen appears. Press the Yes button to allow irrigation to start on a given day or press No to prevent irrigation from starting.
- 4 Press the Next and Back buttons to navigate through the days of the week and repeat the selection process as desired.

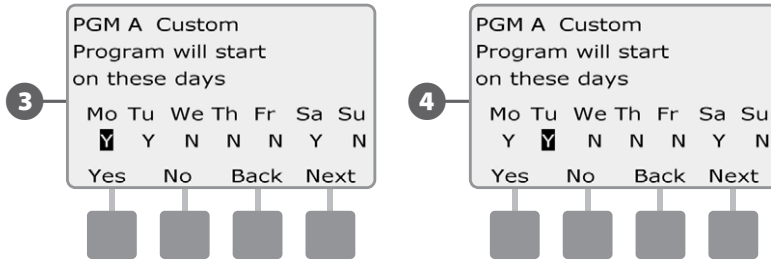

Change the Program Select switch and repeat this process to set Watering Cycles for other programs as desired.

NOTE: Watering day selections carry over to Watering Days dial positions and vice-versa. See Section B, Select Days to Water for more details.

Cyclical Days

Turn the controller dial to Advanced Settings.

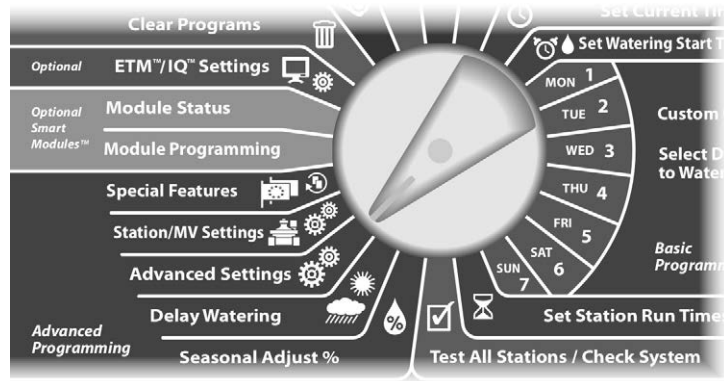

1 The Advanced Settings screen appears with Watering Day Cycles selected; press Next.

2 The Watering Cycle screen appears. Press the Down Arrow button to select Cyclical Days; press Next.

NOTE: If the desired program is not selected, use the Program Select switch to change it. See Section B, Program Select Switch for more details.

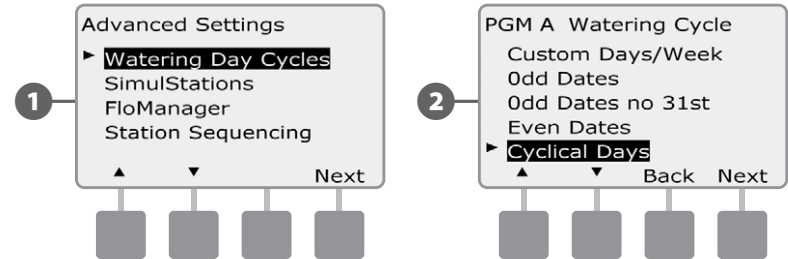

3 The Day Cycle Settings screen appears. Press the + and - buttons to set the watering day cycle (from 1 to 30 days). For example, set to 03 if you want to water every third day; then press Next.

4 Press the + and - buttons to set the first date for the Watering Cycle to begin; then press Next.

- Press and HOLD buttons to accelerate settings for dates.

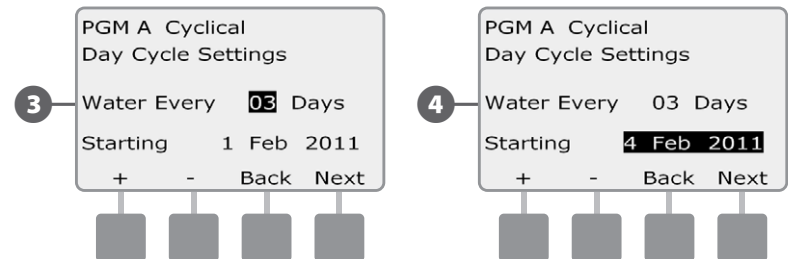

- 5 The Watering Day Cycle screen appears. Press the Yes button to allow irrigation to start on a given day of the week or else press No to prevent irrigation from starting.
- 6 Press the Next and Back buttons to navigate through the days of the week and repeat the selection process as desired.

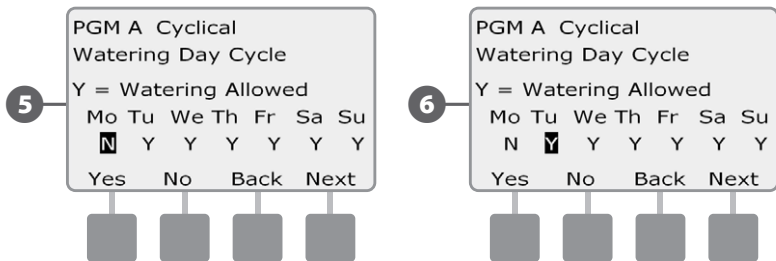

 Change the Program Select switch and repeat this process to set Cyclical Watering for other programs as desired.

 **NOTE:** Watering day selections carry over to Watering Days dial positions and vice-versa. See Section B, Select Days to Water for more details.

Set Up SimulStations™

The ESP-LXME controller defaults to operating a single station at a time. Systems with larger water sources may support operating two or more stations simultaneously.

SimulStations control the maximum number of stations that are allowed to operate at the same time. The number of SimulStations available depends on the number of station modules that are installed.

Maximum SimulStations	
Number of Installed Station Modules	Maximum Number of ESP-LXME SimulStations
1	2
2	4
3	5
4	5

NOTE: The controller will simultaneously operate a maximum of 2 stations on any single station module.

Set SimulStations™ for Program

Turn the controller dial to Advanced Settings.

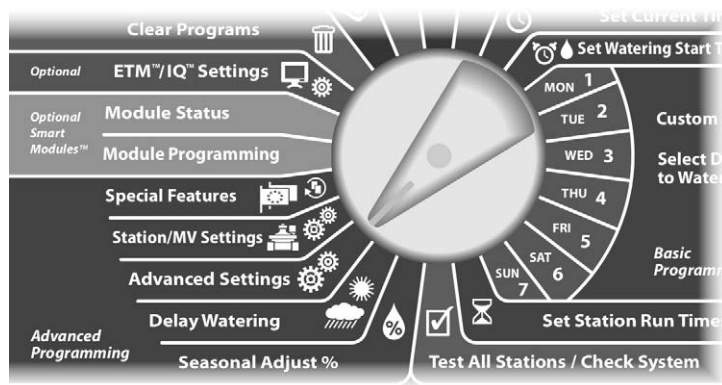

- 1 The Advanced Settings screen appears. Press the Down Arrow button to select SimulStations; then press Next.
- 2 The Station Settings screen appears with PGM SimulStations selected; press Next.

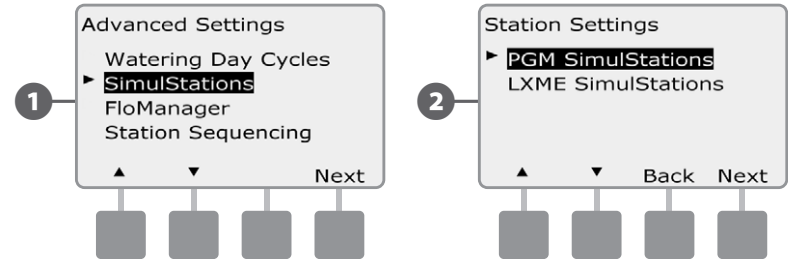

- 3 The Maximum Number of SimulStations screen appears. Press the + and – buttons to set the maximum number of irrigation stations (from 1 to 5) that can operate simultaneously for this program; then press Next.

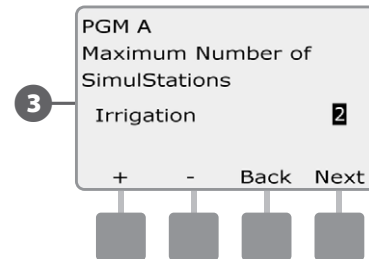

- Change the Program Select switch and repeat this process to set the Maximum Number of Stations for other programs as desired.

Set SimulStations™ for Controller

NOTE: The LXME SimulStations settings will supersede program-level settings. For example, if the LXME setting is 2 but three programs have a maximum setting of 4, then only 2 stations will be allowed to run simultaneously.

Turn the controller dial to Advanced Settings.

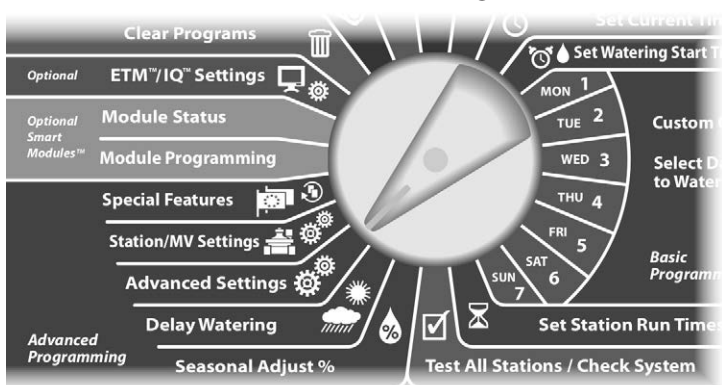

1 The Advanced Settings screen appears. Press the Down Arrow button to select SimulStations; then press Next.

2 The SimulStations screen appears. Press the Down Arrow button to select LXME SimulStations; then press Next.

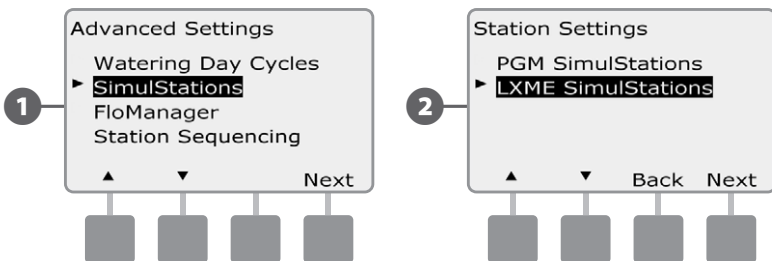

3 The ESP-LXME Maximum Number of SimulStations screen appears. Press the + and – buttons to set the maximum number of irrigation stations (from 1 to 5) that can operate simultaneously; then press Next.

4 Press the + and – buttons to set the maximum number of non-irrigation stations (from 1 to 5).

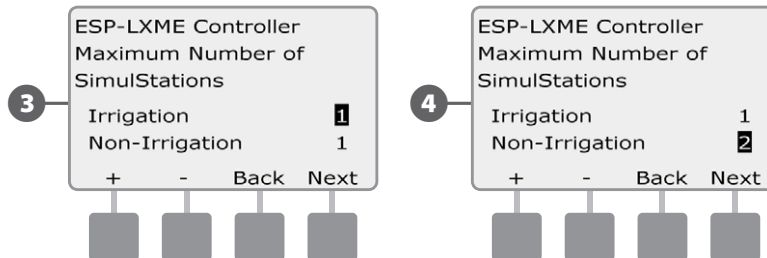

NOTE: The Non-Irrigation SimulStations setting is used to configure the maximum number of Non-Irrigation stations that can operate simultaneously and allows you to balance the number of Irrigation and Non-Irrigation stations that can operate simultaneously.

Station Sequencing

The ESP-LXME offers advanced programming features to optimize water windows. The Station Sequencing option allows you to select from two methods of station sequencing for program operation:

- Sequence by Station Number (system default).
- Sequence by Station Priority (required when using FloManager). This option decreases the overall time required to complete the program when operating multiple stations simultaneously.

Station Sequencing by Station Numbers will select stations to operate in the following order:

1	Station number	1 > 2 > 3 ...
2	Program assignment	A > B > C > D

! **NOTE:** Non-irrigation priority stations will always be selected to operate first.

Station Sequencing by Station Priority will select stations to operate in the following order:

1	Station priority	Non-Irrigation > High > Medium > Low
2	Station run time	Longest run time > shortest run time
3	Station number	1 > 2 > 3 ...
4	Program assignment	A > B > C > D

! **NOTE:** If FloManager is turned ON, then the default Station Sequencing setting is Sequence by Station Priorities. To select Station Sequencing by Station Number, FloManager must first be turned OFF. See Section E, Flow Management, Enable/Disable FloManager for more details.

▶ Turn the controller dial to Advanced Settings.

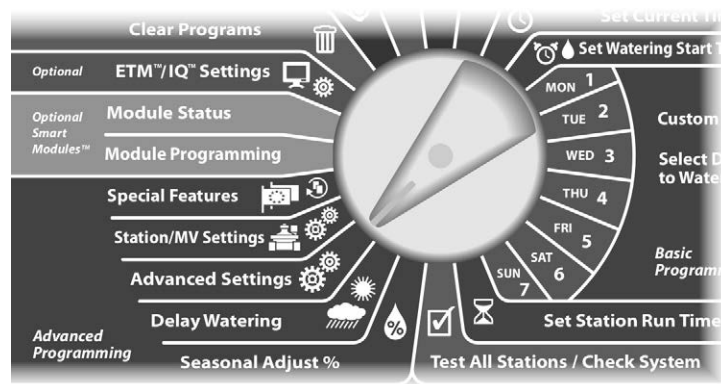

1 The Advanced Settings screen appears. Press the Down Arrow button to select Station Sequencing; then press Next.

2 The Station Sequencing screen appears. Press the + and – buttons to set Station Sequencing by either Station Numbers or Station Priorities, as desired.

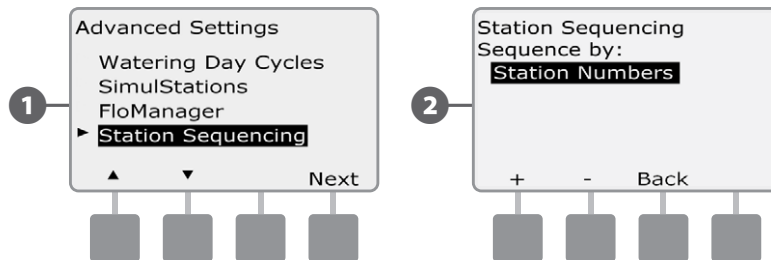

! **NOTE:** When Station Sequencing is set to Sequence by Station Priorities, you can still manually operate stations in station number sequence using the Test All Stations option from the Manual Watering dial position. See Section G, Auxiliary Operation, Manual Watering, Test All Stations for more details.

Station/MV Settings

Station Settings

The Station Settings option tells the ESP-LXME controller how to interact with other stations, the master valve, and the weather sensor.

▶ Turn the controller dial to Station/MV Settings.

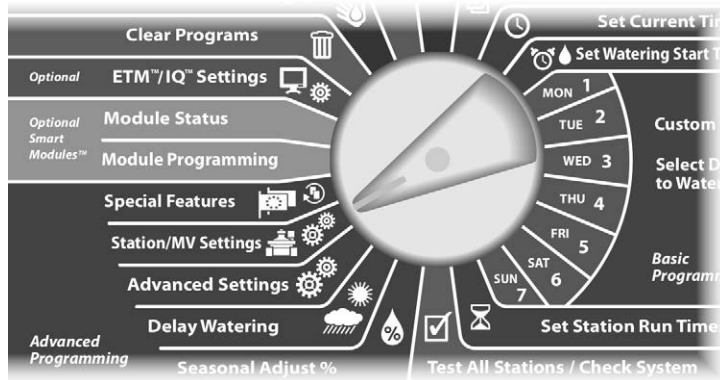

- 1 The Station/MV Settings screen appears with Station Settings selected; press Next.
- 2 The Station Settings screen appears. Press the + and – buttons to enter the desired station number; then press Next.

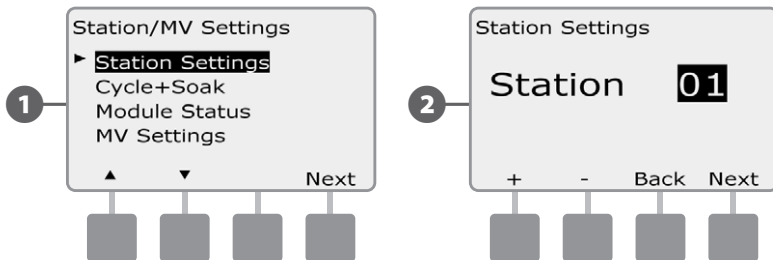

- 3 Press the + and – buttons to enter the number of valves connected to the station; then press Next.

! **NOTE:** Station Priorities are only used when Station Sequencing is set to Sequence by Station Priority. If you're using the default Sequence by Station Numbers, then skip the next step by pressing Next.

- 4 Press the + and – buttons to set Station Priority. Each station can be set to High, Medium, Low or Non-irrigation. Station priority is especially important when multiple programs run simultaneously. When Station Sequencing is set to priorities, the controller will run all high priority stations first, then all medium and finally all low priority, regardless of the station's program settings. Press Next.

! **NOTE:** Non-irrigation stations such as fountains and landscape lighting receive priority to always run, regardless of weather conditions.

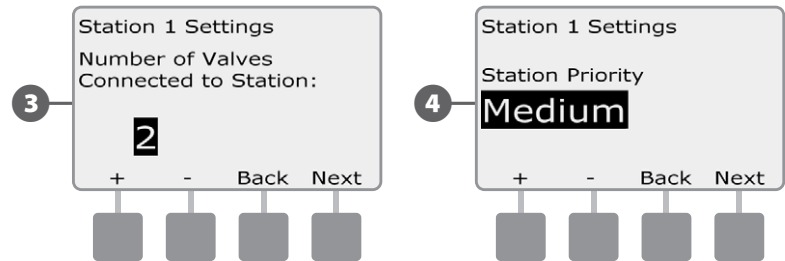

! **NOTE:** When using Station Sequencing by priorities, set station priorities higher for stations you want selected earlier in a program and lower for stations you want selected later in a program.

- 5 Press the + and – buttons to select Yes if the station requires a master valve, otherwise select No; then press Next.
- 6 The Weather Sensor Assignment screen lets you select whether a station obeys or ignores the installed weather sensor. Press the + and – buttons to select Obey or Ignore; then press Next.

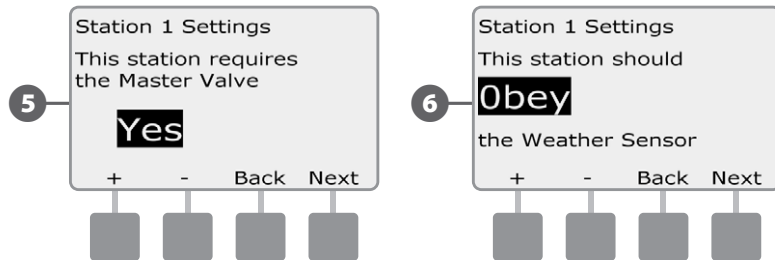

! **NOTE:** The weather sensor can be turned on (Active) or off (Bypassed) using the Weather Sensor switch on the controller front panel.

↻ Repeat this process to set up additional stations.

Set Up Cycle+Soak™

The ESP-LXME controller Cycle+Soak™ feature allows water to be applied to stations intermittently and without creating complex programs. It can apply to any station and is useful for locations such as hillsides which can be difficult to irrigate effectively.

Cycle+Soak consists of two settings, the cycle time (how long a station will run before soaking) and soak time (how long irrigation is paused before applying another cycle). For example, a station can be set up to receive 15 minutes of irrigation in three 5 minute cycles, with two 10 minutes periods of soak time in between waterings.

NOTE: Cycle+Soak settings apply to stations no matter which programs it may be used in.

Turn the controller dial to Station/MV Settings.

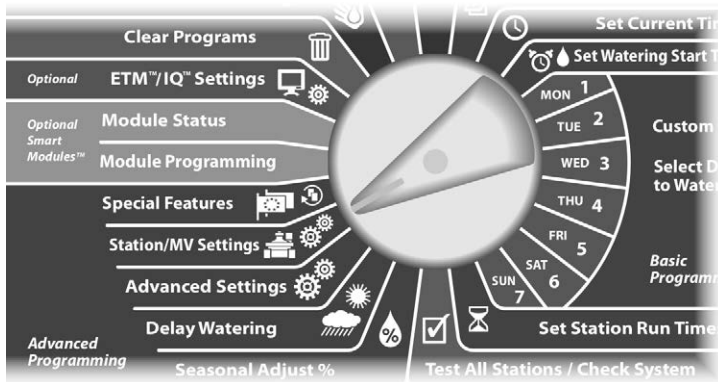

- 1 The Station/MV Settings screen appears. Press the Down Arrow button to select Cycle+Soak; then press Next.
- 2 The Cycle+Soak screen appears. Press the + and – buttons to enter the desired station number; then press Next.

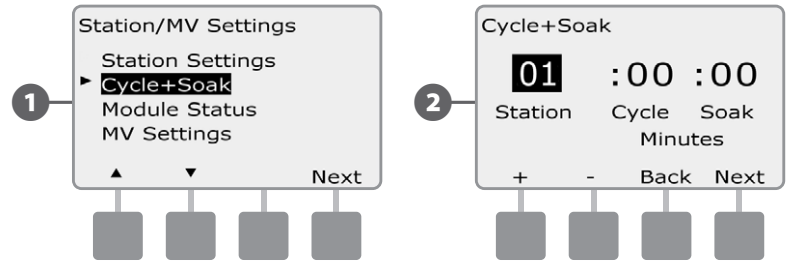

- 3 Press the + and – buttons to set the Cycle time (between 1-60 minutes). Or to cancel Cycle+Soak on that station, set to 0 minutes; then press Next.

- Press and HOLD buttons to accelerate settings for minutes.

- 4 Press the + and – buttons to set the Soak time (between 1-60 minutes). Or to cancel Cycle+Soak on that station, set to 0 minutes; then press Next.

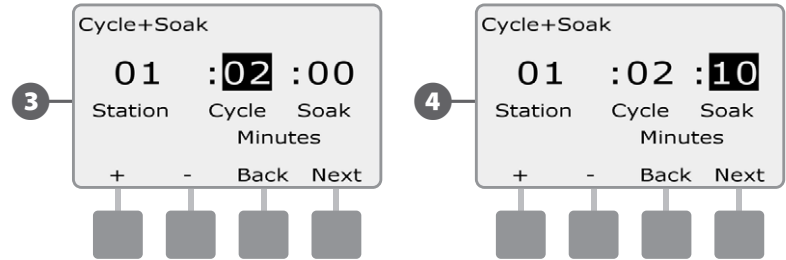

- NOTE:** Consider using short Soak times, particularly if your watering schedule or Water Window is short. Long soak times could prevent irrigation from completing prior to the end of the Water Window. See previous Water Windows for more details.

Repeat this process to set up Cycle+Soak on other stations.

Module Status

The *Module Status* option displays the status of any station module installed in Slots 1-4.

- ▶ Turn the controller dial to Station/MV Settings.

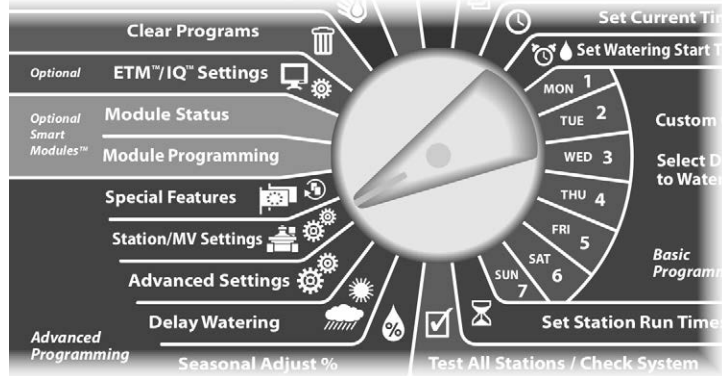

- 1 The Station/MV Settings screen appears. Press the Down Arrow button to select Module Status; then press Next..
- 2 The Module Status screen appears. The current status of any installed station modules is displayed.

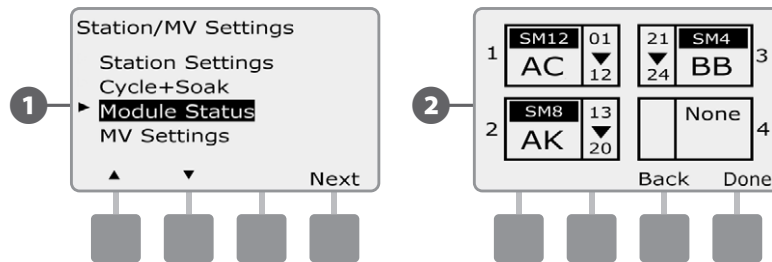

MV Settings

The MV Settings option tells the ESP-LXME controller what type of master valve (MV) is used by your irrigation system.

The ESP-LXME supports one master valve which must be set up in the controller. Both Normally Open master valves (NOMVs) and Normally Closed master valves (NCMVs) are supported.

Since Normally Open master valves (NOMVs) are always open, it's sometimes helpful to cycle them closed for a minute in order to maintain the continuity of your valve diaphragms and solenoids. The controller can be programmed to perform this task automatically.

➡ Turn the controller dial to Station/MV Settings.

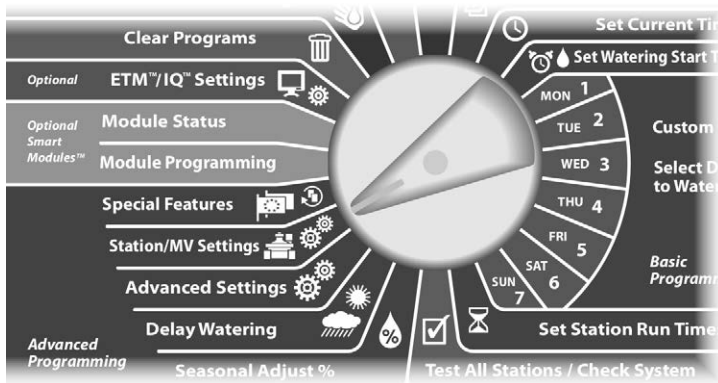

- 1 The Station/MV Settings screen appears. Press the Down Arrow button to select MV Settings; then press Next.
- 2 The MV Settings screen appears. Press the + and – buttons to select Normally Open or Normally Closed for the MV; then press Next.

! **NOTE:** Standard irrigation valves are Normally Closed (powered to open). Normally Open valves are specialty valves that are powered to close.

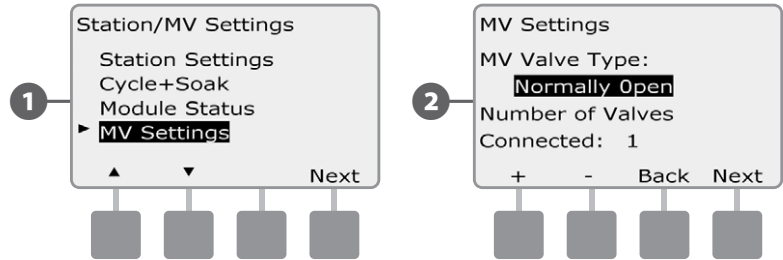

- 3 Press the + and – buttons to enter the number of valves that are connected to the master valve circuit; then press Next.
- 4 If the MV Valve Type is set to Normally Open, the NOMV Cycling screen appears. Press the + and – buttons to enable NOMV cycling and to select the start time; then press Next.

! **NOTE:** The NOMV will be cycled closed for 60 seconds on the first day of each month. Since irrigation is suspended when the NOMV is shut, choose a time when irrigation is not scheduled for this operation.

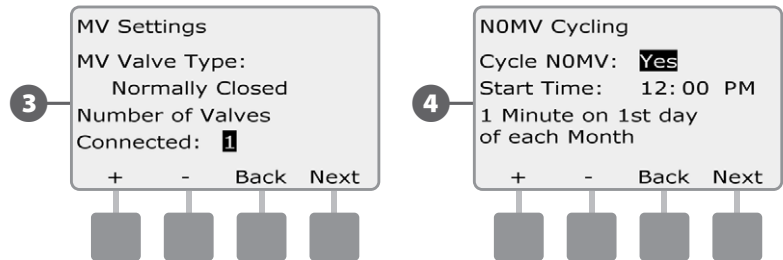

Section E - Flow Management

The ESP-LXME controller offers several tools to dynamically manage the hydraulics of the irrigation system including:

FloManager™

Standard feature of the LXME controller which manages flow demands on the water source.

FloWatch™

Optional add-in module which monitors the actual flow rate of the system and reacts to flow problems.

Set Flow Units

To use FloManager or FloWatch you first need to set the measurement units for flow management.

- 1 Turn the controller dial to Special Features.

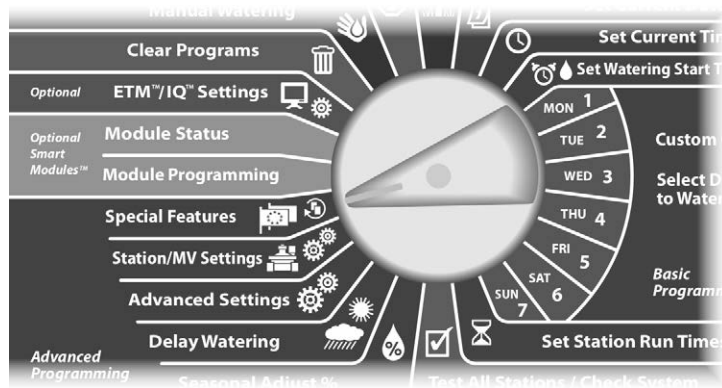

- 1 The Special Features screen appears. Press the Down Arrow button to select Set Flow Units; then press Next.
- 2 The Flow Units screen appears. Press the + and – buttons to select the desired flow measurement (English or metric); then press Next.

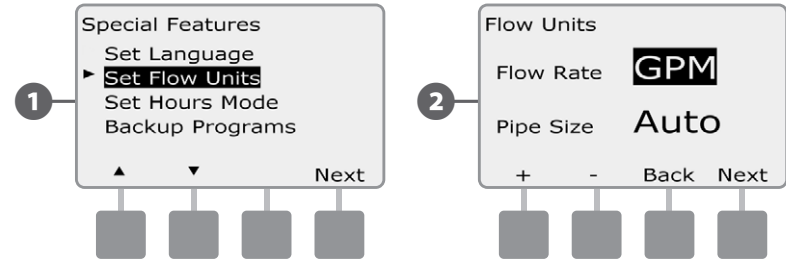

- 3 Press the + and – buttons to select the desired pipe size measurement (English or metric).

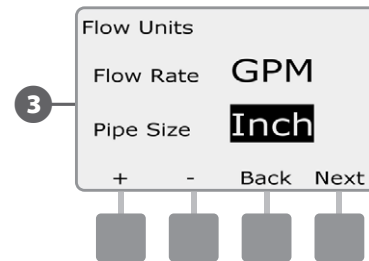

FloManager™ Overview

FloManager is a standard feature of the ESP-LXME controller which manages flow demands on the water source and can be used with or without an actual flow sensor.

Managers of larger irrigation systems can struggle to find enough hours per week to irrigate the site. This issue is more prevalent today with mandated restrictions on the number of irrigation days per week and hours per day. Operating your irrigation system at the most efficient flow rate has several advantages:

- Decreases the overall time required to irrigate the site
- Manages the flow and pressure delivered to each valve
- Saves power for systems with pumps

If the irrigation system water source can support the operation of multiple stations simultaneously, FloManager can provide automated hydraulic management, optimizing the available water.

FloManager, working with the station priority and SimulStation settings, will dynamically select combinations of stations to operate simultaneously in order to utilize as much of the available water from the water source as possible. Each station will still operate for the programmed run time and the maximum capacity of the water source will never be exceeded.

FloManager™ Requirements

FloManager will require the following information:

- FloManager Flow Rate. This is the maximum capacity of the irrigation system water source (water meter or pump).
- Station Flow Rates. If you do not have a flow sensor, you can enter the station flow rates manually.

NOTE: If the optional Flow Smart Module and flow sensor are installed, the station flow rates required for FloManager can be calculated automatically. Refer to FloWatch Operation for instructions on using the Learn Flow Utility.

Set Up and Use FloManager™

Enable (Or Disable) FloManager™

- 1 Turn the controller dial to Advanced Settings.

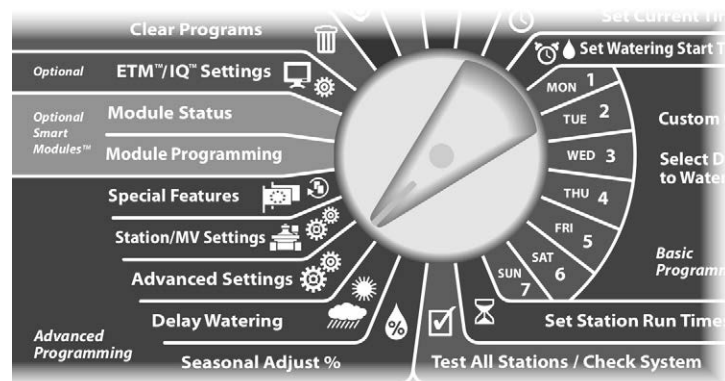

- 1 The Advanced Settings screen appears. Use the Down Arrow to select FloManager; then press Next.
- 2 The FloManager screen appears with FloManager On/Off selected; press Next.

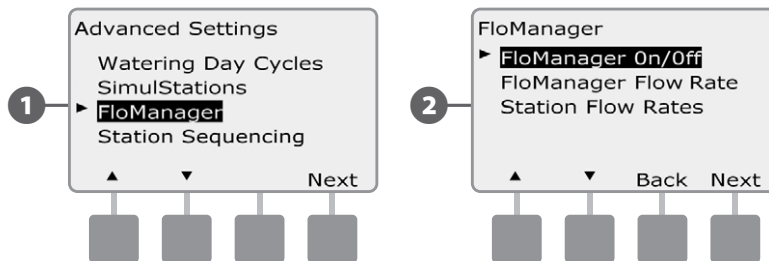

- 3 Press the On button to enable FloManager, or press Off to disable.
- 4 If Station Sequencing was previously set to Station Numbers, then turning FloManager ON will automatically change the setting to Station Priorities. Press Accept to make the change or else press Reject. See Section D, Advanced Programming, Station Sequencing for more details.

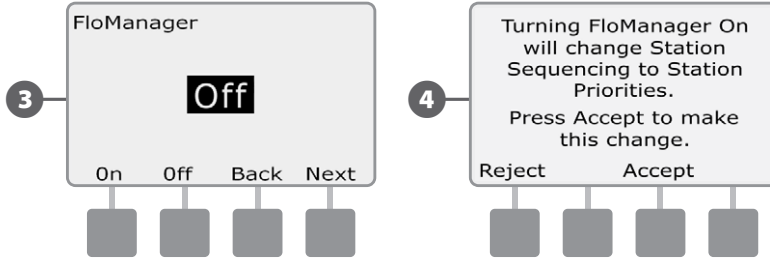

Set FloManager™ Flow Rate

FloManager needs to know the maximum capacity of the irrigation system water source.

- Turn the controller dial to Advanced Settings.

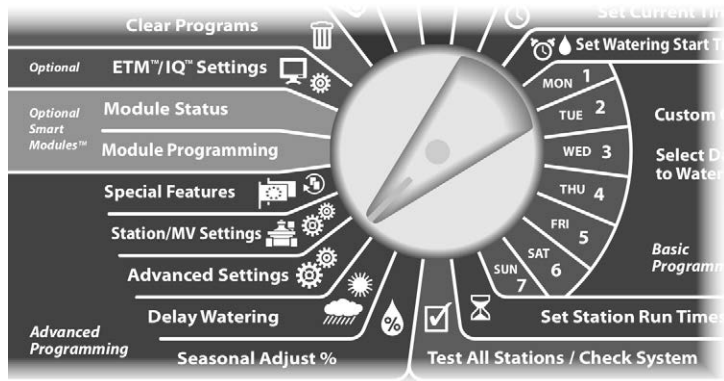

- The FloManager Max Flow Rate screen appears. Use the + and - buttons to enter the water source maximum flow rate.

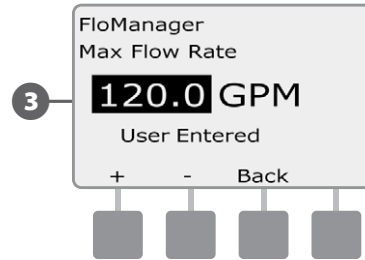

- The Advanced Settings screen appears with Watering Day Cycles selected. Press the Down Arrow button to select FloManager; then press Next.
- The FloManager screen appears with FloManager On/Off selected. Use the Down arrow to select FloManager Flow Rate; then press Next.

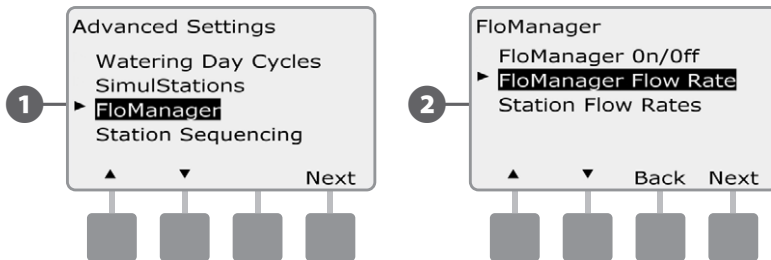

Set Station Flow Rates Manually

Flow rates for each station can be entered manually.

NOTE: If the optional FSM-LXME Flow Smart Module is installed then flow can be learned automatically. This is the easiest, most accurate method to enter flow readings. See Learn Flow section for more details.

Turn the controller dial to Advanced Settings.

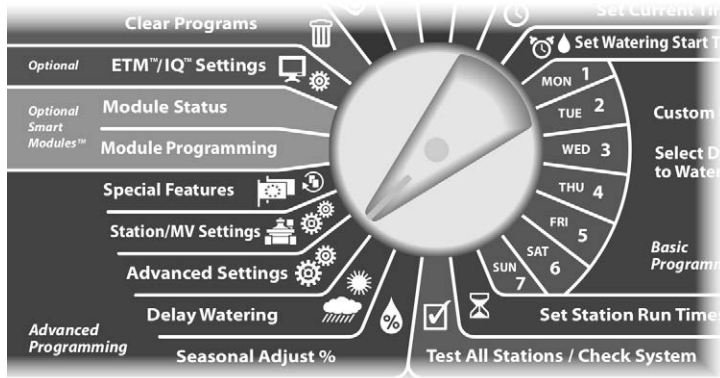

1 The Advanced Settings screen appears with Watering Day Cycles selected. Press the Down Arrow button to select FloManager; then press Next.

2 The FloManager screen appears with FloManager On/Off selected. Use the Down arrow to select Station Flow Rates; then press Next.

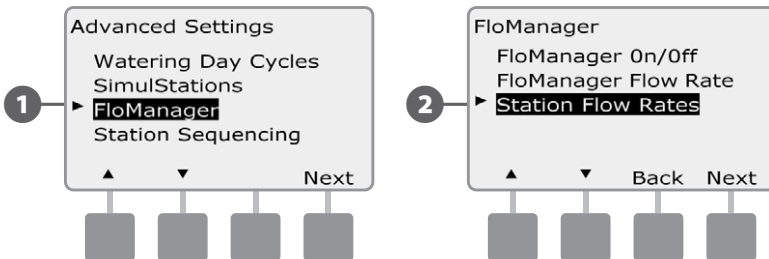

3 The Station Flow Rates screen appears. Press the + and - buttons on the left to select the desired station number.

4 Press the + and - buttons on the right to enter the Flow Rate for the selected station.

- Press and HOLD buttons to accelerate settings for Flow Rate.

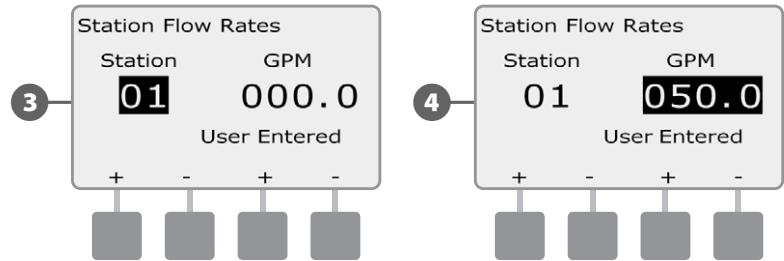

Repeat this process to manually set up Flow Rates for additional stations as desired.

FloWatch™ Overview

The ESP-LXME controller can provide full-featured flow sensing by installing the optional FSM-LXME Flow Smart Module.

! **NOTE:** FloWatch flow sensing requires installation of the optional FSM-LXME Flow Smart Module and installation of a flow sensor and a master valve at the water source point of connection to the irrigation system.

FloWatch features include:

- Learn Flow Utility
- Seek and Eliminate Excessive Flow (SEEF)
- Seek and Eliminate Low Flow (SELF)
- Flow alarm and water use reporting

The ESP-LXME controller with installed FSM-LXME Flow Smart Module is compatible with the Rain Bird FS-Series Flow Sensors. Third party flow sensors are supported through entry of KFactor and Offset values. Normally-open and normally-closed master valves are supported.

Flow sensing benefits include:

- Water use tracking
- Automatic reaction to flow problems
- Minimizes property owner liability by limiting water loss and property damage caused by broken pipes or sprinklers

FloWatch™ Configuration

FloWatch configuration includes:

- Learn Flow Station Rates. Each station will be operated and the steady flow rate recorded. The recorded station flow rate is compared to the actual flow from the flow sensor each time the station operates.
- SEEF and SELF settings include deviation percentage, settling time and reaction to a problem.

Flow Sensor Hardware Installation

Installation of the Flow Smart Module (FSM-LXME), a flow sensor, and a master valve are required to use FloWatch.

Flow Smart Module

Replace the BM-LXME Base Module with the FSM-LXME Flow Smart Module.

! **NOTE:** If you purchased a flow-enabled version of the ESP-LXME Controller such as the ESP-LXMEF, this step is unnecessary, since your controller shipped with the FSM-LXME Flow Smart Module.



FSM-LXME Flow Smart Module

! **NOTE:** The Flow Smart Module includes a jumper wire connecting the weather sensor (SEN) terminals. Do not remove the jumper wire unless you install a weather sensor.

- 1 Remove the BM-LXME Base Module from Slot 0 by pressing in on the two release buttons on either side of the module.

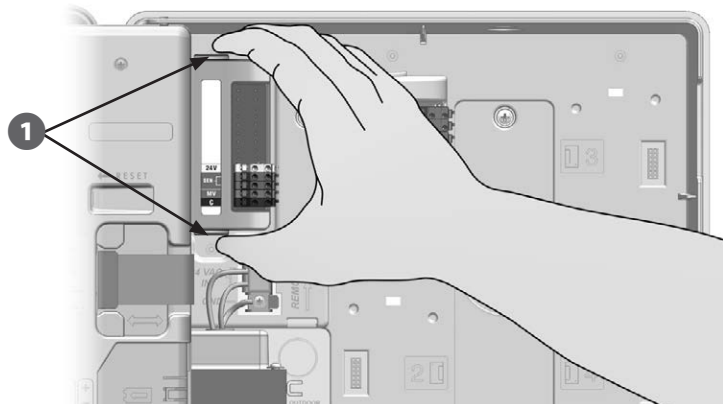

 **CAUTION:** Be careful not to bend the pins in the sockets when installing the module.

- 2 Orient the connector on the bottom of the FSM-LXME Flow Smart Module with the connection socket in Slot 0 on the controller backplane.

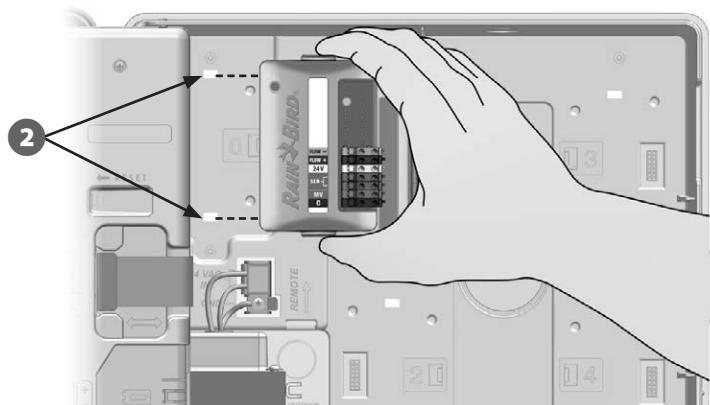

- 3 Carefully fasten the module onto the controller backplane, pressing firmly until it snaps into place. The red light on the module will flash on and off once if the module is installed correctly. If the light does not flash, verify the module is properly seated.

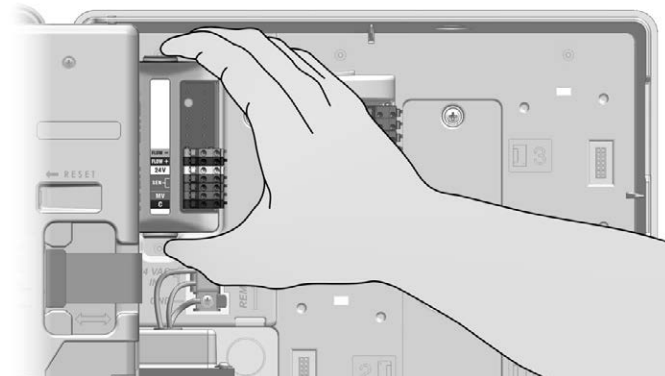

Connect Flow Sensor

- 1 Install the flow sensor in the field according to the manufacturer's instructions, and run the flow sensor wire to the ESP-LXME controller.

! **NOTE:** Flow sensor wiring recommendations:

- Use a separate PE-39 #19 AWG cable for connecting the flow sensor to the Flow Smart Module. The maximum wire run length is 450 feet (138 meters).
- The connection from the PE-39 cable to the flow sensor must be made with direct burial (DB) type connectors. Use Rain Bird DBRY20 or 3M DBR/Y-6 splice kits only.
- Minimize wire splices.
- Any cable with broken, torn, or damaged insulation should be replaced.

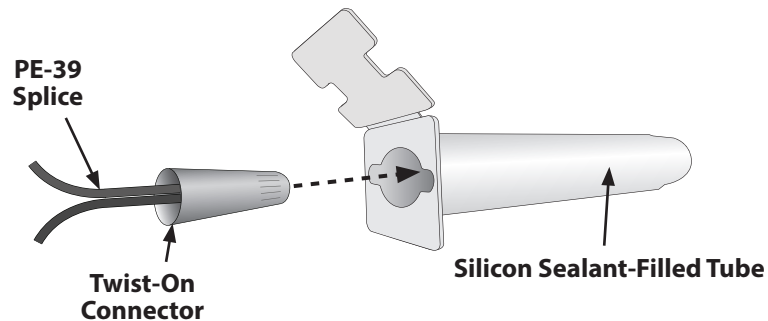

! **NOTE:** Push the connector all the way into the tube to ensure a watertight seal.

Rain Bird DBRY20 Splices

- 2 Route the flow sensor wire through the knockout on the bottom of the controller.
- 3 Connect the flow sensor wire to the Flow + and Flow - inputs. When finished, tug gently on the wires to make sure the connections are tight.

! **NOTE:** For Rain Bird FS-Series flow sensors, connect the red sensor wire to the red (+) terminal and the black sensor wire to the grey (-) terminal.

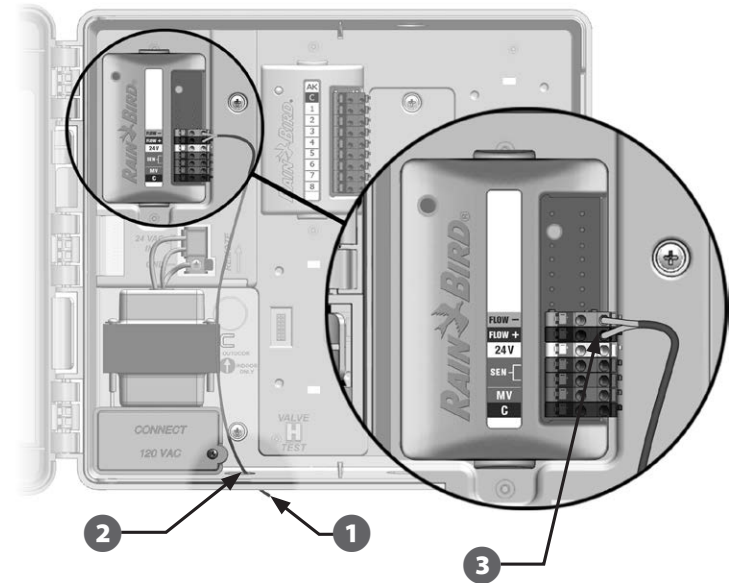

! **NOTE:** The blue light on the FSM-LXME Flow Smart Module will flash as flow is measured by the flow sensor.

Module Programming

Setup Flow Sensor

Turn the controller dial to Module Programming.

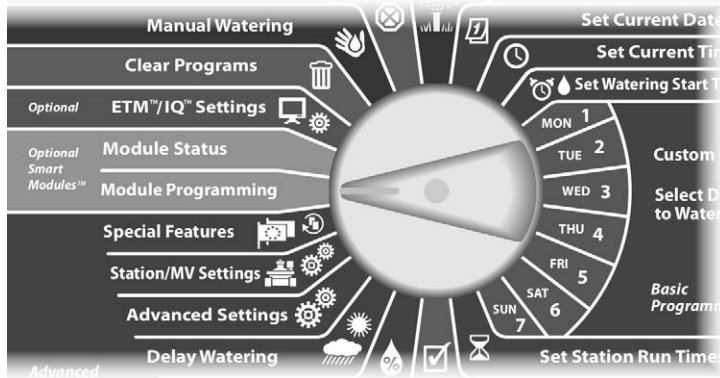

- 1 The Smart Module PGM screen appears with Flow Smart Module selected; press Next.
- 2 The Flow Smart Module PGM screen appears with Flow Sensor Setup selected; press Next.

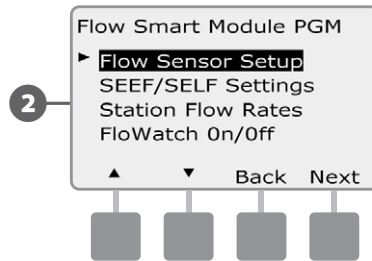
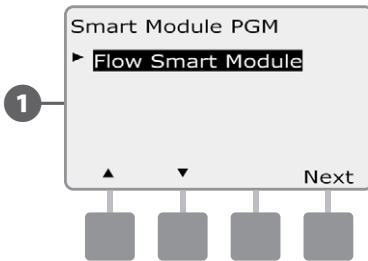

NOTE: If a FSM-LXME Flow Smart Module is not installed, the screens displayed on pages 59 through 72 will not be displayed.

3 The Flow Sensor Setup screen appears. Press the + and - buttons to select the type of sensor that is installed.

NOTE: Some flow sensor types require extra parameter settings, such as inside pipe diameter or K-factor and Offset. Consult the manufacturers documentation or contact Rain Bird for assistance if required.

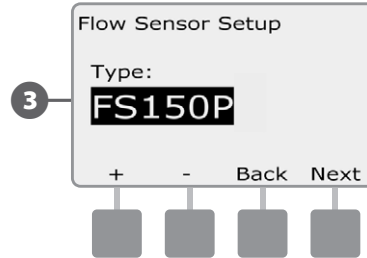

SEEF and SELF Settings and Actions

To most effectively use FloWatch, you will want to first set your SEEF and SELF thresholds and actions. SEEF stands for Seek and Eliminate Excessive Flow and deals with how you want your controller to respond when excessive flow is occurring, as might be the case with a mainline break. SELF stands for Seek and Eliminate Low Flow and deals with what the controller should do when low flow is present, as might be the case during a pump failure, municipal water supply issue or when a valve fails to open.

▶ Turn the controller dial to Module Programming.

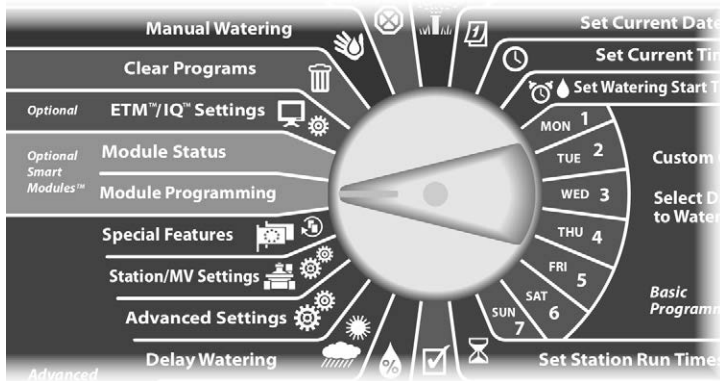

- 1 The Smart Module PGM screen appears with Flow Smart Module selected; press Next.
- 2 The Flow Smart Module PGM screen appears. Use the Down Arrow to select SEEF/SELF Settings; then press Next.

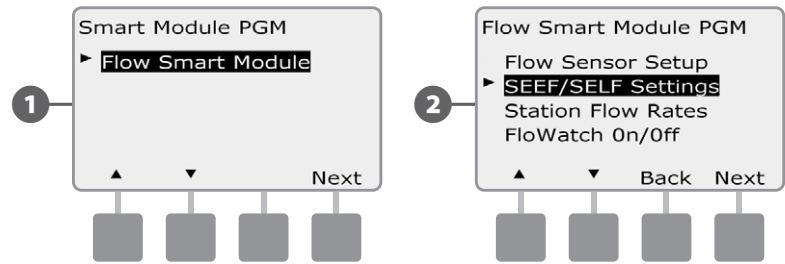

- 3 The SEEF Settings screen appears with High Flow Threshold selected, allowing you to set the top limit (between 105-200%) of station flow rate that must be achieved to be considered excessive. Press the + and – buttons to set the High Flow Threshold; then press Next.

- Press and HOLD buttons to accelerate settings for percentages.

NOTE: Consider using the default setting of 130% (or higher) for SEEF High flow Threshold. Using a lower percentage can result in false alarms due to normal hydraulic variability.

- 4 Settling Time is selected, allowing you to set the minimum time (from 3-10 minutes) that a flow rate must remain at (or above) the threshold before the controller will issue an alarm or take action. Press the + and – buttons to set the Settling Time; then press Next.

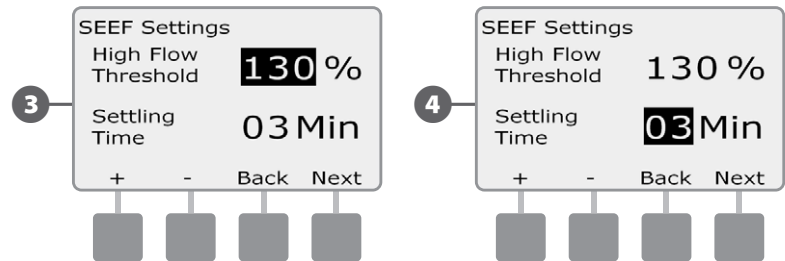

- 5** The SEEF Actions screen appears, allowing you to set the controller's behavior when a SEEF condition exists.
- A.** Diagnose and Eliminate allows the controller to determine if the high flow condition is due to a problem on the mainline (broken pipe, stuck valve, etc) or downstream of one of the valves that was running when the high flow condition was detected. The controller will eliminate the high flow condition by closing the Master Valve to eliminate a mainline problem or closing the problem valve to eliminate a problem with a station.
 - B.** Shut Down and Alarm instructs the controller to shut down the Master Valve when a high flow condition is detected. The controller will not attempt to diagnose if the problem is on the mainline or downstream of a valve.
 - C.** Alarm Only allows the controller to issue an alarm condition, but take no other action.

Press the + and – buttons to set the SEEF Action; then press Next.

- 6** The SELF Settings screen appears with Low Flow Threshold selected, allowing you to set the bottom limit (between 1-95%) that a station must achieve to be considered low flow. Press the + and – buttons to set the Low Flow Threshold; then press Next.
- Press and HOLD buttons to accelerate settings for percentages.

! **NOTE:** Consider using the default setting of 70% (or lower) for SEEF Low flow Threshold. Using a higher percentage can result in false alarms due to normal hydraulic variability.

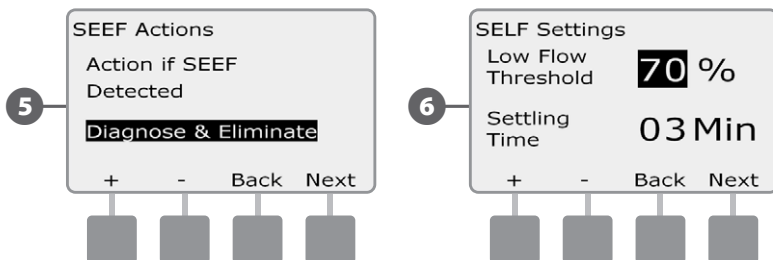

- 7** Settling Time is selected, allowing you to set the time limit (from 3-10 minutes) that a station flow rate must remain at (or below) the threshold before the controller will issue an alarm or take action. Press the + and – buttons to set the Settling Time; then press Next.

- 8** The SELF Actions screen appears, allowing you to set the controller's behavior when a SELF condition exists.

- A.** Diagnose and Eliminate allows the controller to determine if the low flow condition is due to a problem on the mainline (affects all valves) or downstream of one of the valves that was running when the low flow condition was detected. The controller will eliminate the low flow condition by closing the Master Valve to eliminate a mainline problem or closing the problem valve to eliminate a problem with a station.
- B.** Shut Down and Alarm instructs the controller to shut down the Master Valve when a low flow condition is detected. The controller will not attempt to diagnose if the problem is on the mainline or downstream of a valve.
- C.** Alarm Only allows the controller to issue an alarm condition, but take no other action.

Press the + and – buttons to set the SELF Action; then press Next.

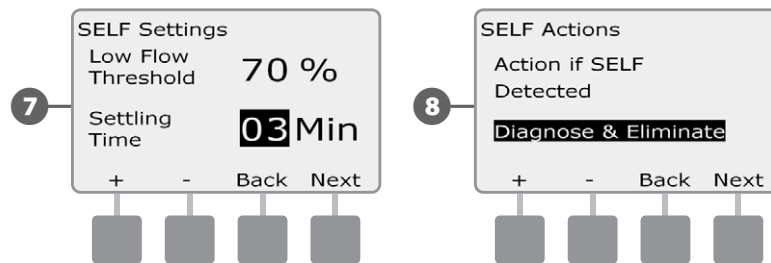

! **NOTE:** If the selected action for **both** SEEF and SELF is Alarm Only, then the system is not disabled and the Delay to Re-Enable screen will not be shown.

- 9 The Delay to Re-Enable screen appears, allowing you to select how long (from 0 minutes to 24 hours) before your system is re-enabled to allow watering. If the flow condition still exists, SEEF or SELF will shut down the system again. Selecting the default of 0 minutes configures the controller to stay shut down until the flow alarm is manually cleared.

Press the + and – buttons to set hours before Re-Enable; then press Next.

- Press and HOLD buttons to accelerate settings for hours and minutes.

- 10 Press the + and – buttons to set minutes before Re-Enable; then press Next.

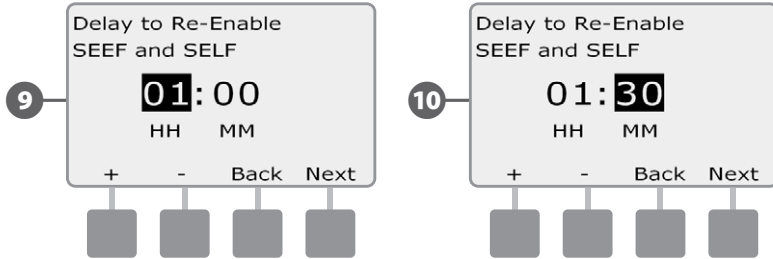

! **NOTE:** SEEF and SELF settings are not active until FloWatch is activated.

Station Flow Rates

Learn Flow Automatically (All Stations)

Turn the controller dial to Module Programming.

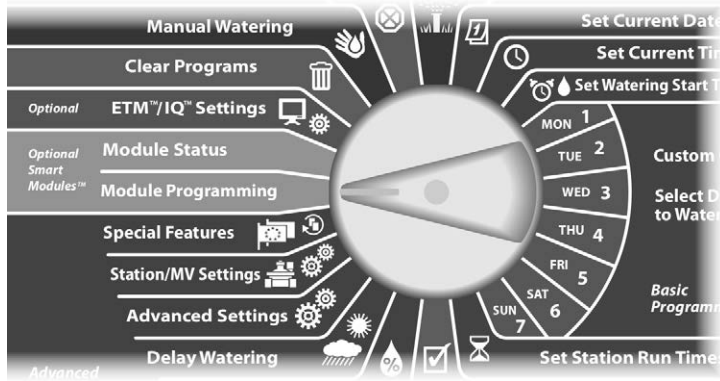

- 1 The Smart Module PGM screen appears with Flow Smart Module selected; press Next.
- 2 The Flow Smart Module PGM screen appears. Press the Down arrow to select Station Flow Rates; press Next.

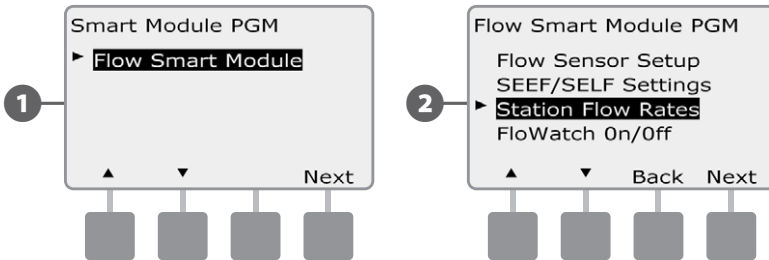

- 3 The Set Flow Rates screen appears with Learn Flow selected; press Next.
- 4 The Learn Flow screen appears with All Stations selected; press Next.

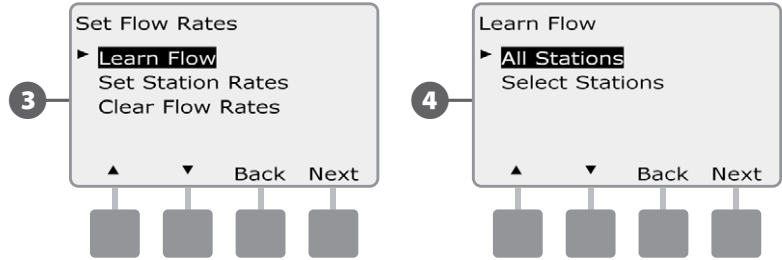

- NOTE:** Ensure you have runtimes set up for all stations included in a Learn Flow exercise prior to setting up a Learn Flow. Only stations with run times will be included in Learn Flow operation.
- 5 A Learn Flow confirmation screen appears; press Next.
 - 6 A second Learn Flow confirmation screen appears; press Next.

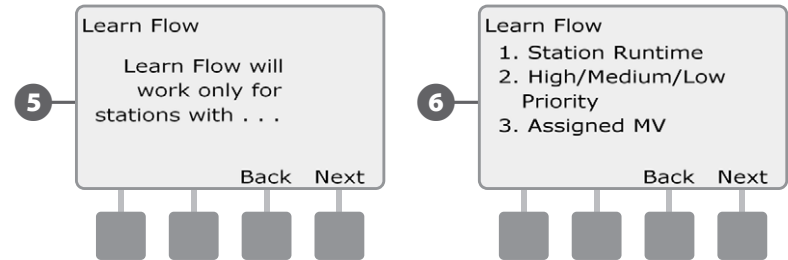

7 The Start Learn Flow screen appears. Press + and - to set the start time; then press Start.

- Press and HOLD buttons to accelerate settings for hours and minutes.

! **NOTE:** You can choose to run the exercise Now or choose a timed delay of up to 24 hours.

8 An overwrite warning screen appears; press Start.

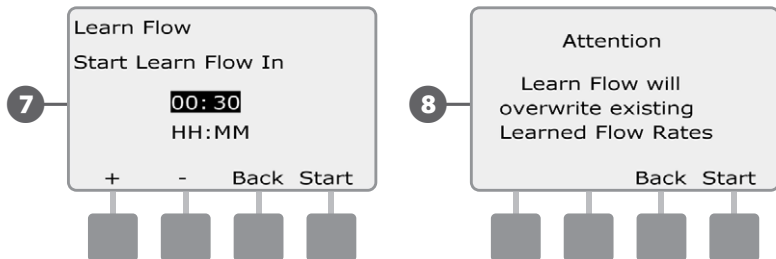

9 The Learn Flow Starting confirmation screen appears, confirming the delay time until the Learn Flow operation will start.

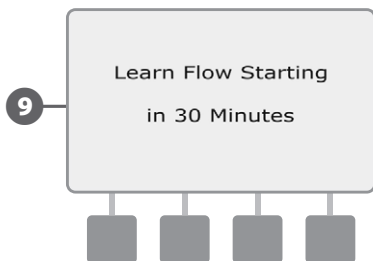

! **NOTE:** The Learn Flow Utility can take up to 5 minutes per station.

Learn Flow Automatically (Custom Stations)

Turn the controller dial to Module Programming.

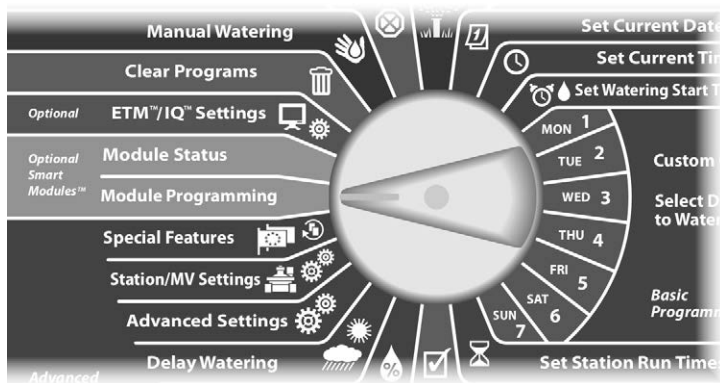

1 The Smart Module PGM screen appears with Flow Smart Module selected; press Next.

2 The Flow Smart Module PGM screen appears. Press the Down arrow to select Station Flow Rates; press Next.

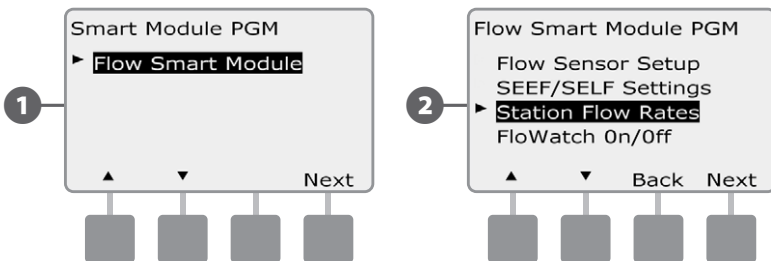

3 The Set Flow Rates screen appears with Learn Flow selected; press Next.

4 The Learn Flow screen appears. Press the Down Arrow to choose Select Stations; then press Next.

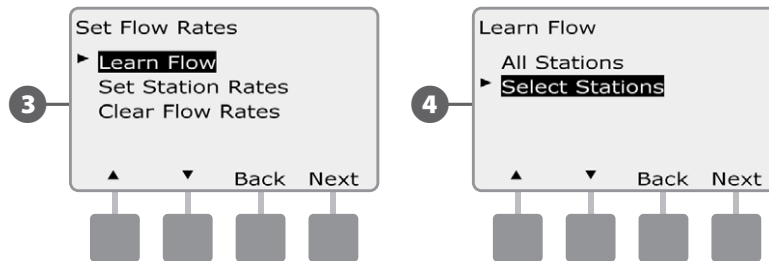

NOTE: Ensure you have runtimes set up for all stations included in a Learn Flow exercise prior to setting up a Learn Flow. If stations without run times are included in a Learn Flow exercise, the controller will issue an error message and cancel the Learn Flow exercise.

5 A Learn Flow confirmation screen appears; press Next.

6 A second Learn Flow confirmation screen appears; press Next.

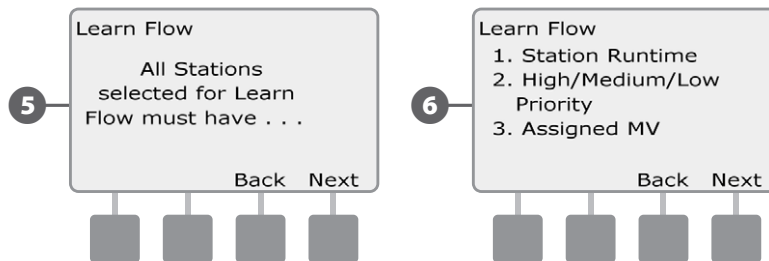

7 Press the Yes and No buttons to select the stations you would like to include. Press Next and Back buttons to select stations; then press Next.

8 Press the + and – buttons to set the time delay for when you want the Learn Flow exercise to start; then press Start.

- Press and HOLD buttons to accelerate settings for hours and minutes.

! **NOTE:** You can choose a delay between 0 hours, 0 minutes up to 24 hours.

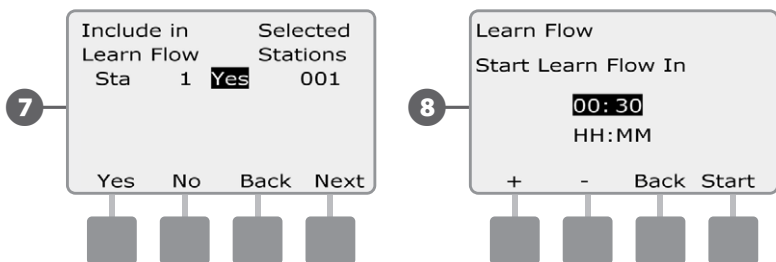

9 A confirmation screen appears; press Start again to set the Learn Flow exercise.

10 The Learn Flow Starting confirmation screen appears, confirming the delay time until the Learn Flow operation will start.

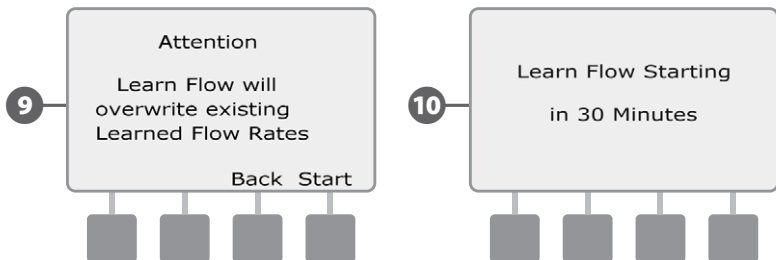

! **NOTE:** Station flow rates can still be entered manually if desired. See FloManager section for details.

! **NOTE:** The Learn Flow Utility can take up to 5 minutes per station.

Set Station Flow Rates Manually

Allowing the controller to Learn Flow automatically is the easiest, most accurate method to enter flow readings, but flow sensing hardware and the Flow Smart Module are required for this. However, even if you do not have flow sensing hardware installed you can manually enter flow rates for one or more stations or flow zones before or after an automatic Learn Flow exercise.

Turn the controller dial to Module Programming.

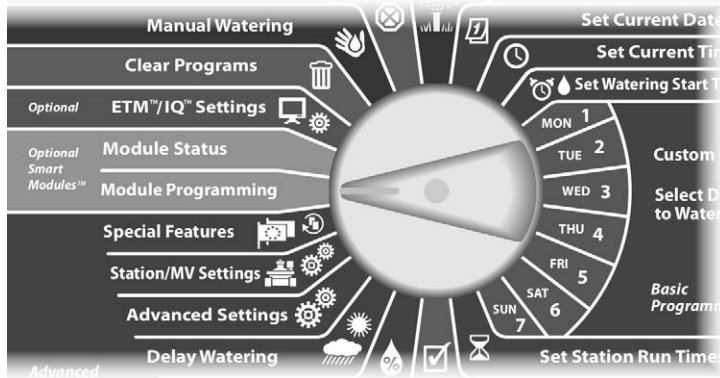

- 1 The Smart Module PGM screen appears with Flow Smart Module selected; press Next.
- 2 The Flow Smart Module PGM screen appears with Set Flow Rates selected; press Next.

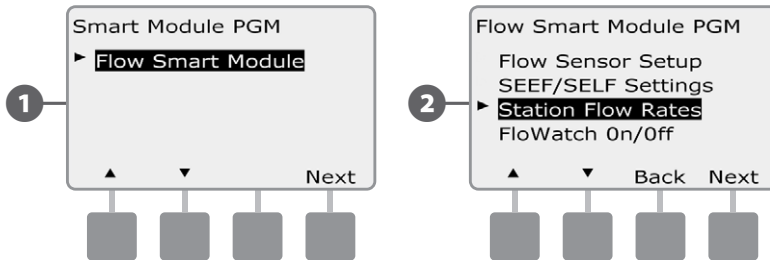

- 3 The Set Flow Rates screen appears. Press the Down Arrow button to select Set Station Rates; then press Next.
- 4 Press + and - (buttons 1 and 2) to select the desired station number; then press - (button 4).

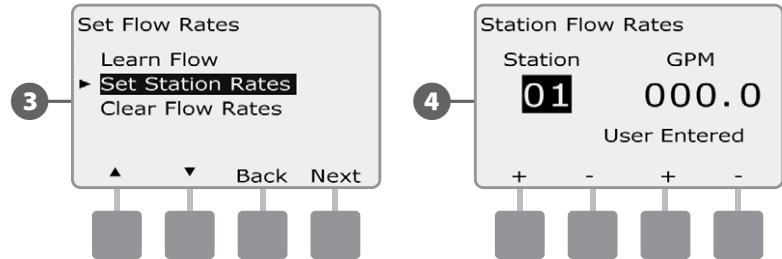

- 5 Press + and - (buttons 3 and 4) to enter the desired Flow Rate for that station. Press - (buttons 2 and 4) to navigate between the station and flow rate fields.
 - Press and HOLD buttons to accelerate settings for GPM.

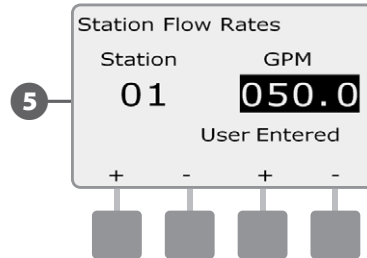

- Repeat this process to manually set up Flow Rates for additional stations as desired.

Clear Flow Rates

Occasionally it may be desired to clear the previously learned or user entered flow rates and start all over again.

▶ Turn the controller dial to Module Programming.

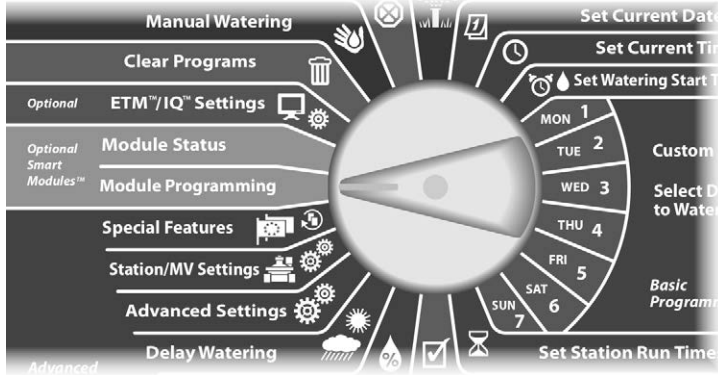

- 1 The Smart Module PGM screen appears with Flow Smart Module selected; press Next.
- 2 The Flow Smart Module PGM screen appears. Press the Down Arrow button to select Station Flow Rates; press Next.

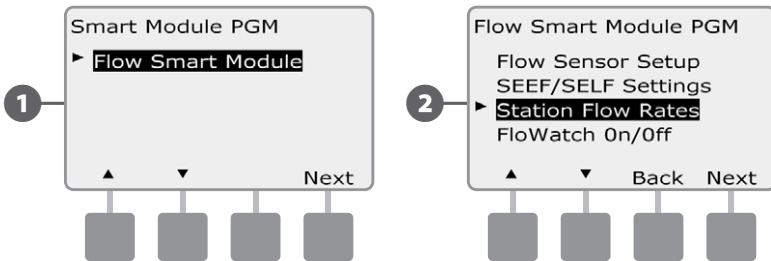

- 3 The Set Flow Rates screen appears. Press the Down Arrow button to select Clear Flow Rates; then press Next.
- 4 The confirmation screen appears; press Next to clear flow rates.

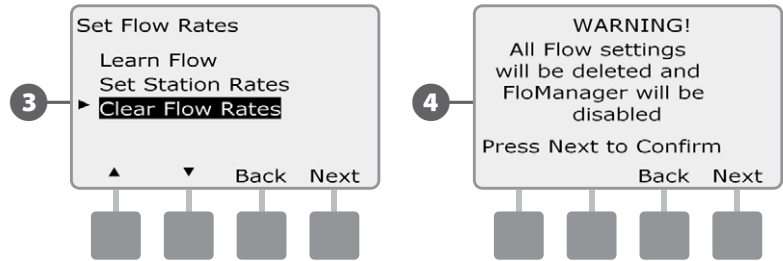

Enable (or Disable) FloWatch™

- Turn the controller dial to Module Programming.

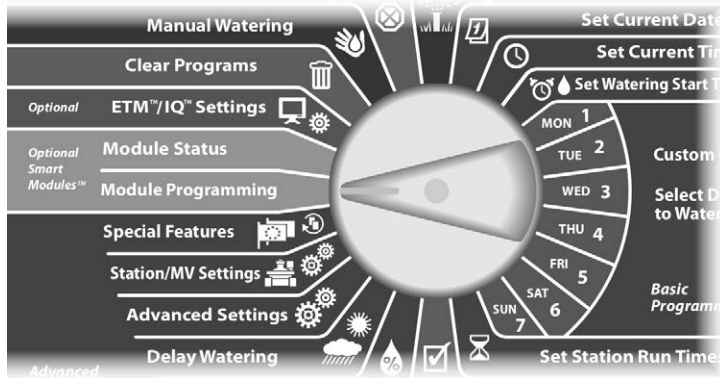

- ➊ The Smart Module PGM screen appears with Flow Smart Module selected; press Next.
- ➋ The Flow Smart Module PGM screen appears. Use the Down Arrow to select FloWatch On/Off; then press Next.

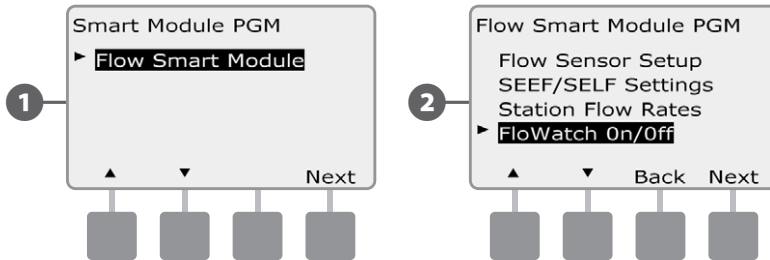

- ➌ The FloWatch screen appears. Press the On button to enable FloWatch, or else press Off to disable

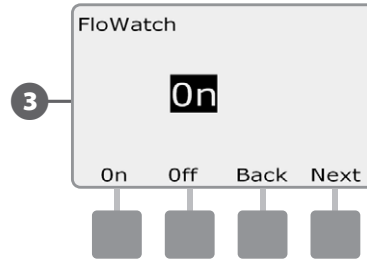

- ⚠ **NOTE:** Once FloWatch is enabled we recommend that you Learn Flow for all stations if you have not already done so. This will allow FloWatch to react appropriately to the SEEF and SELF settings.

Module Status

View and Clear Flow Alarms

Occasionally a flow condition in excess of your SEEF settings or below your SELF settings will be detected. If your controller is set up to issue alarms for these conditions, the alarm light will illuminate and detailed descriptions of the Flow Alarm conditions will be created.

View Station Flow Alarms

Turn the controller dial to Module Status.

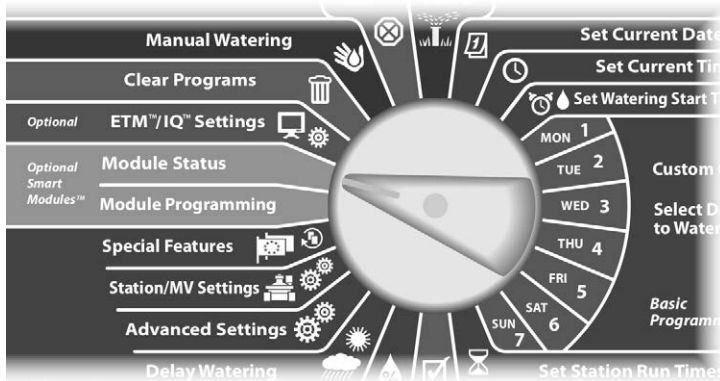

- 1 The Smart Module Status screen appears with Flow Smart Module selected; press Next.
- 2 The Flow Module Status screen appears with View Flow Alarms selected; press Next.

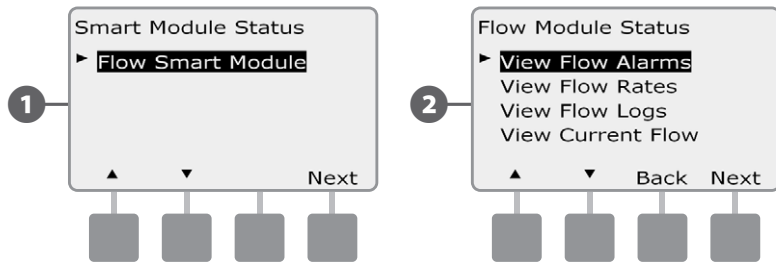

- 3 The Review/Clear Alarms screen appears with Station Flow Alarms selected; press Next.
- 4 The Station Flow Alarms screen appears. Press the Up and Down arrows to view the Flow Alarms. Stations with Flow Alarm conditions will display "Yes"- only alarmed stations will be shown.

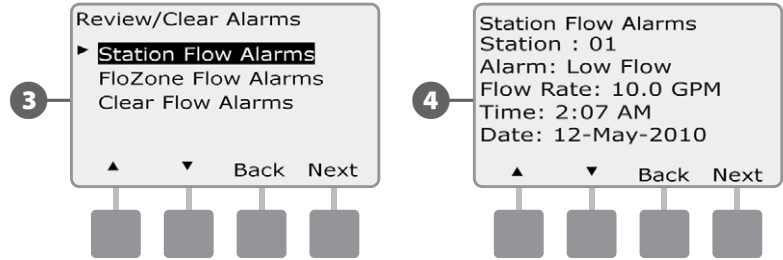

View Mainline Flow Alarms

- Turn the controller dial to Module Status.

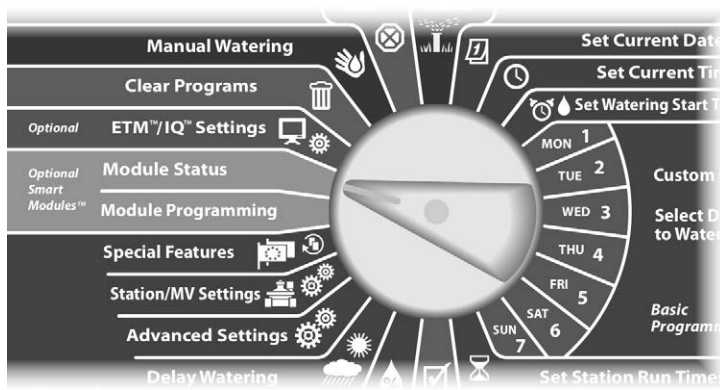

- The Smart Module Status screen appears with Flow Smart Module selected; press Next.
- The Flow Module Status screen appears with View Flow Alarms selected; press Next.

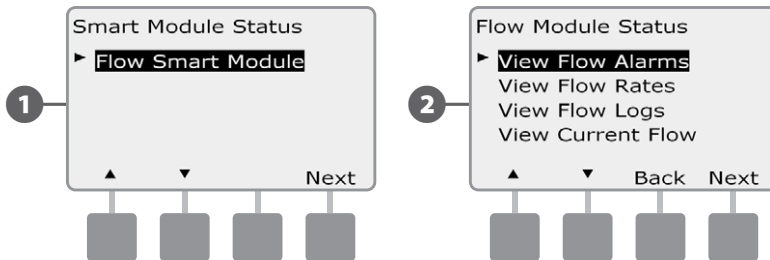

- The Review/Clear Alarms screen appears. Press the Down Arrow button to select Mainline Flow Alarms; then press Next.
- The Mainline Flow Alarms screen appears. If no Mainline Flow Alarms have been posted you will see the screen below.

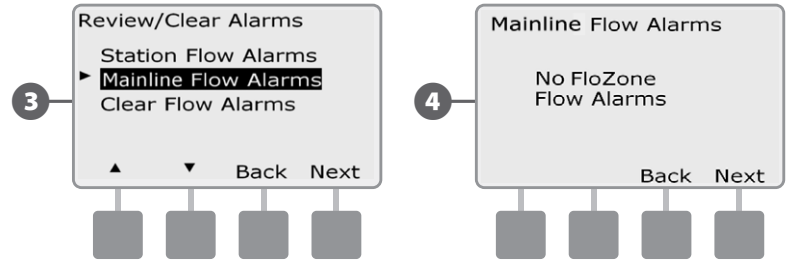

Note each station which has an alarm, then See Clear Flow Alarms in this section for more details on how to clear flow alarms.

NOTE: Mainline alarms indicate alarms for mainline flow conditions, not stations.

Clear Flow Alarms

- Turn the controller dial to Module Status.

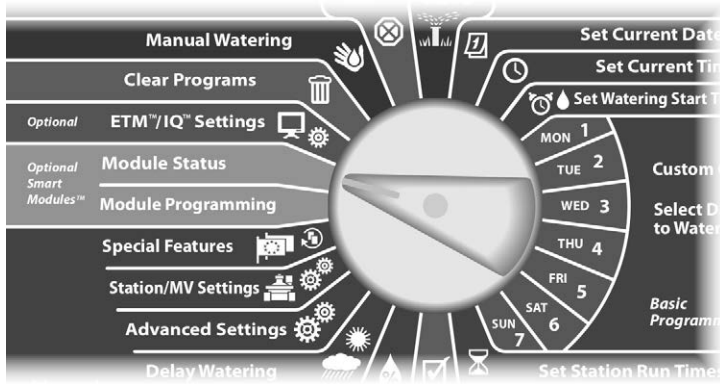

- The Smart Module Status screen appears with Flow Smart Module selected; press Next.
- The Flow Module Status screen appears with View Flow Alarms selected; press Next.

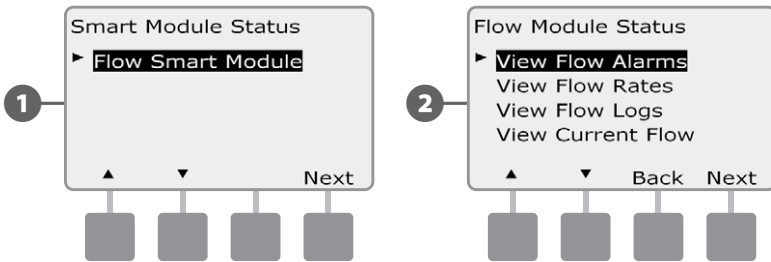

- The Review/Clear Alarms screen appears. Press the Down Arrow button to select Clear Flow Alarms; then press Next.
- The Clear Flow Alarms screen appears with all current Flow Alarms displayed and you will have the opportunity to clear each. It may be helpful to record which stations have Flow Alarm conditions prior to clearing them.

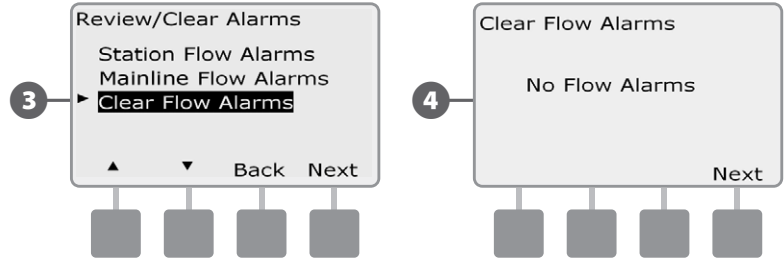

- NOTE:** Mainline alarms indicate alarms for mainline flow conditions, not stations.

View Flow Rates

Occasionally you may want to view flow rates for a station or the water source.

- Turn the controller dial to Module Status.

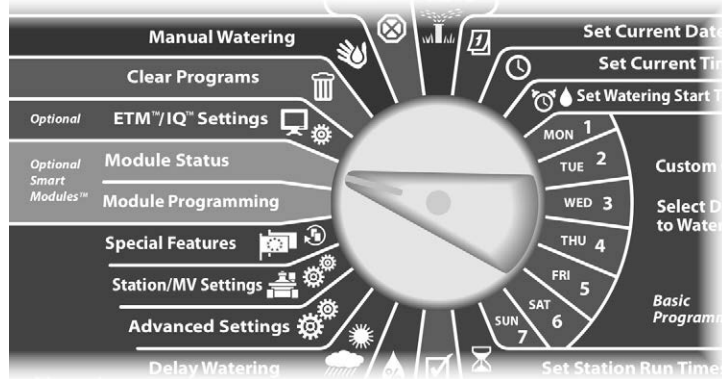

- The Smart Module Status screen appears with Flow Smart Module selected; press Next.
- The Flow Module Status screen appears. Press the Down Arrow button to select View Flow Rates; then press Next.

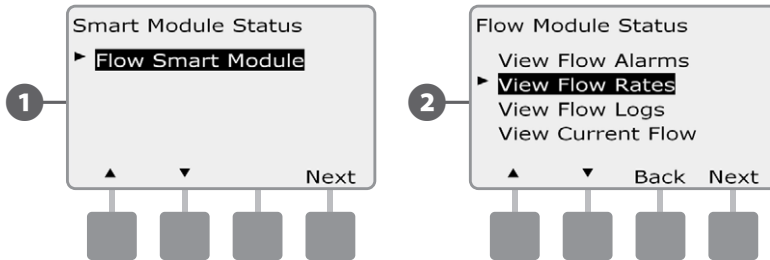

- The Flow Rates screen appears with View Station Rates selected; press Next.
- The Station Flow Rates screen appears. Press the + and - buttons to select the desired station number. The normal flow rate for each station will display to the right, and the source of the flow rate (Learned or User Entered) displays below it.

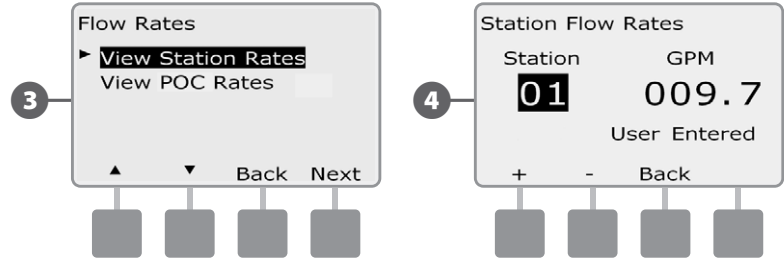

- NOTE:** POC rate is the maximum flow rate for the water source.

View and Clear Flow Logs

With FloWatch enabled, the controller will automatically track the volume of water flowing through the system. This can be useful for checking your actual water consumption against your water bill.

- ▶ Turn the controller dial to Module Status.

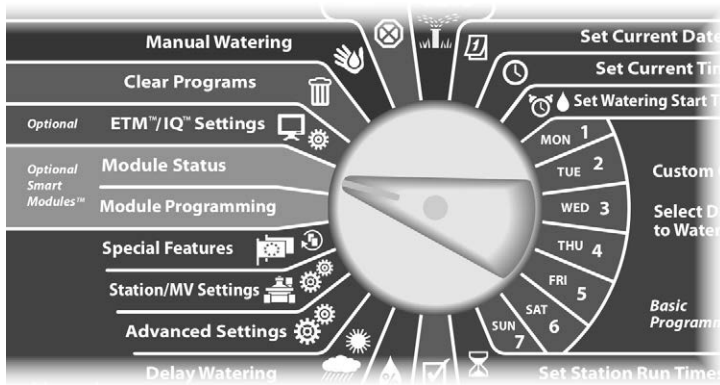

- 1 The Smart Module Status screen appears with Flow Smart Module selected; press Next.
- 2 The Flow Module Status screen appears. Press the Down Arrow button to select View Flow Logs; then press Next.

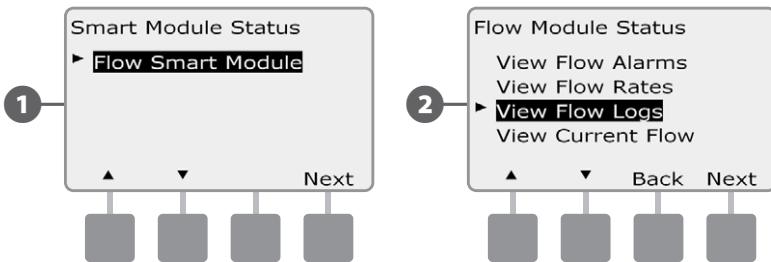

- 3 The Flow Logs screen appears, showing month-to-date and last month water consumption (in gallons).
- 4 Press the Days button to change the view to the last 30 days and previous 30 days.

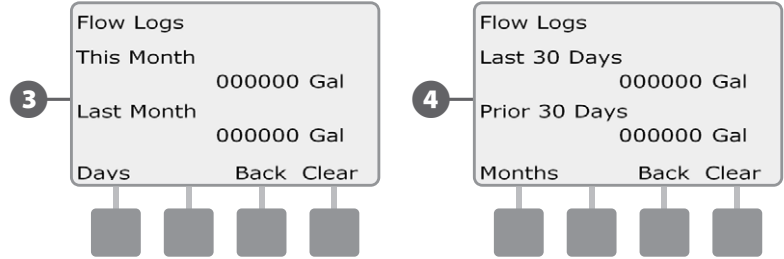

- 5 If you would like to clear the log information, press the Clear button.

NOTE: Pressing Clear from either the monthly or daily screen will clear BOTH monthly and daily flow log data.

- 6 The confirmation screen appears; press Yes to clear the logs.

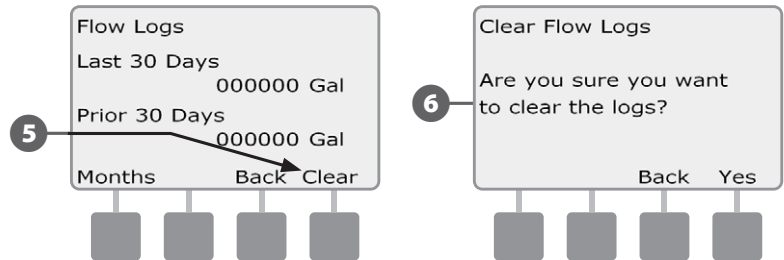

View Current Flow

Occasionally it may be useful to check the current flow rate and how it compares to previously learned or user input flow rates.

- Turn the controller dial to Module Status.

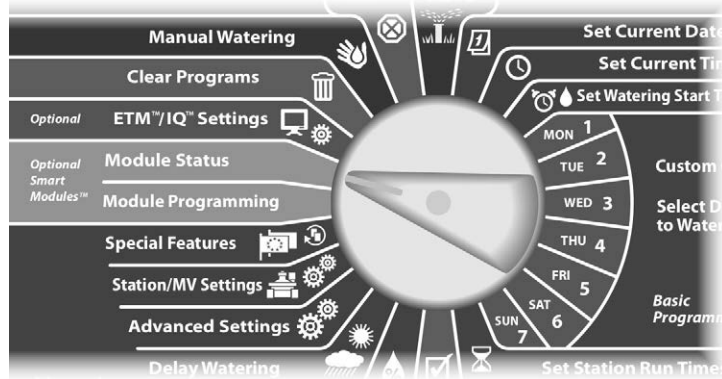

- The Smart Module Status screen appears with Flow Smart Module selected; press Next.
- The Flow Module Status screen appears. Press the Down Arrow button to select View Current Flow; then press Next.

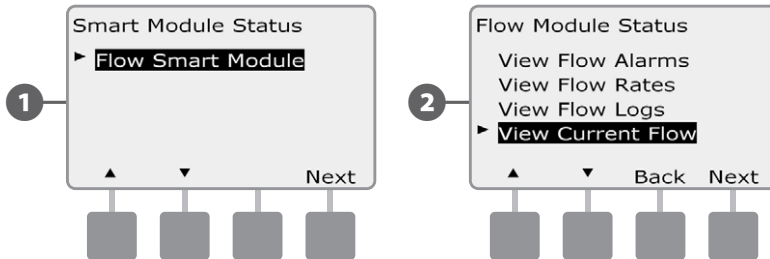

- Current and expected flow will display.

NOTE: Expected flow is from previously user-entered or learned flow. The deviation or percentage comparison of current flow to expected flow will display so you can see how close the system is to a SEEF or SELF condition (see Setting Up SEEF and SELF for more details).

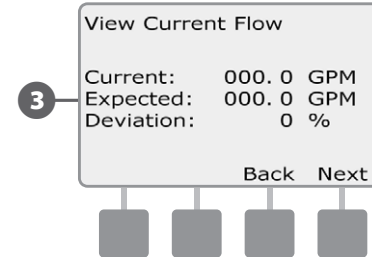

this page intentionally left blank

Section F - Options & Special Features

Set Language

You can set the ESP-LXME controller to one of six supported languages; English, Spanish, French, Portuguese, Italian or German. Changes to the default language affect all screens and menus.

- ▶ Turn the controller dial to Special Features.

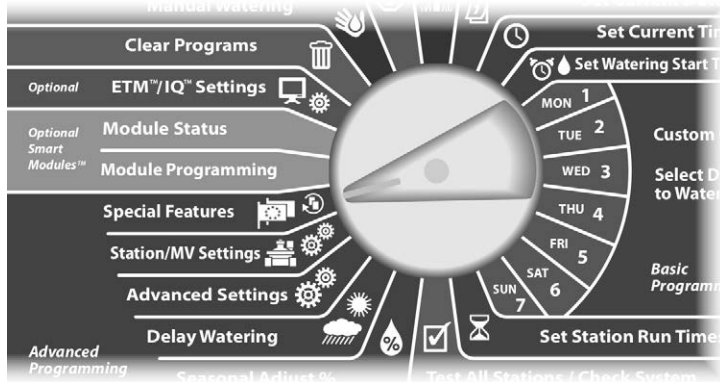

- The Special Features screen appears with Set Language selected; press Next.
- NOTE:** If the controller is set to a language you do not speak, Set Language is the top item on the Special Features main menu.
- The Set Language screen appears. Press the + and – buttons to select the desired language.

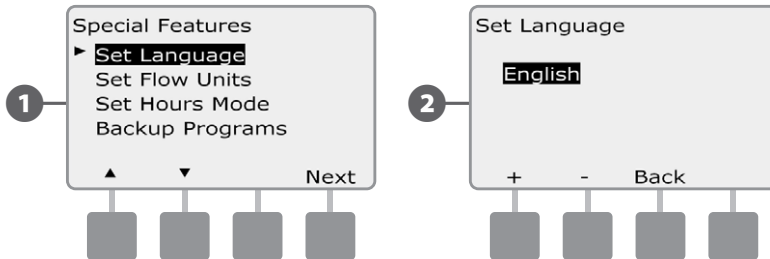

Set Hours Mode

You can set the ESP-LXME controller to display time in one of three hours modes: Auto (default for your region), AM/PM or 24 Hour.

- ▶ Turn the controller dial to Special Features.

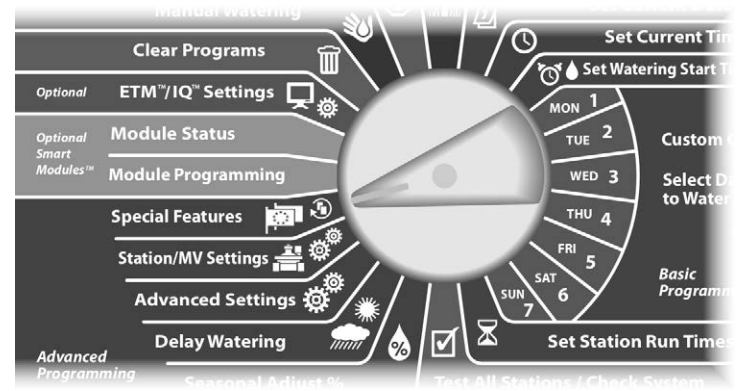

- The Special Features screen appears with Set Language selected. Press the Down Arrow button to select Set Hours Mode; then press Next.
- The Set Hours Mode screen appears. Press the + and – buttons to select the desired hours mode.

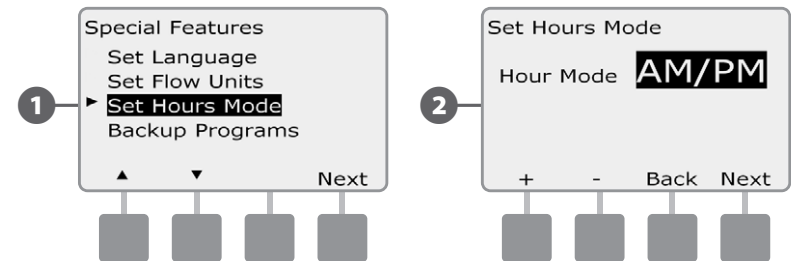

Backup and Recall Programs

The ESP-LXME controller comes standard with a simple to use backup programs feature.

Backup Programs allows you to save your programs as Contractor Default and then recall them at a later time. It also includes a Delayed Recall feature that lets you save a normal irrigation schedule as the Backup and then restore it later automatically. This may be useful for new seed or sod where frequent irrigation can be programmed to occur until a set date when Delayed Recall automatically returns the controller programming to the normal irrigation schedule.

CAUTION: The Backup Programs feature saves and restores ALL irrigation programming in ALL programs (A, B, C & D).

Store Default Programs

Turn the controller dial to Special Features.

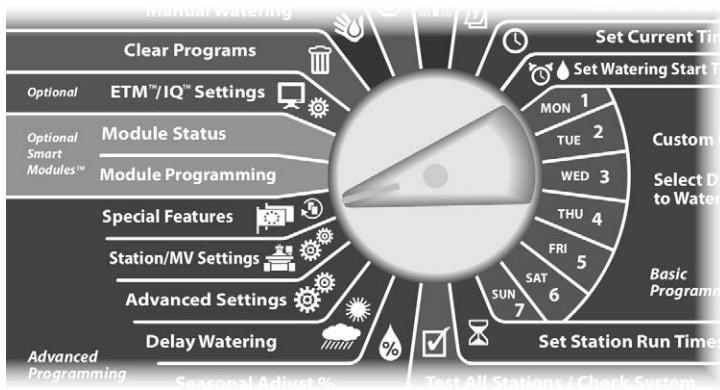

- 1 The Special Features screen appears. Press the Down Arrow button to select Backup Programs; then press Next.
- 2 The Backup Programs screen appears with Store Programs selected; press Next.

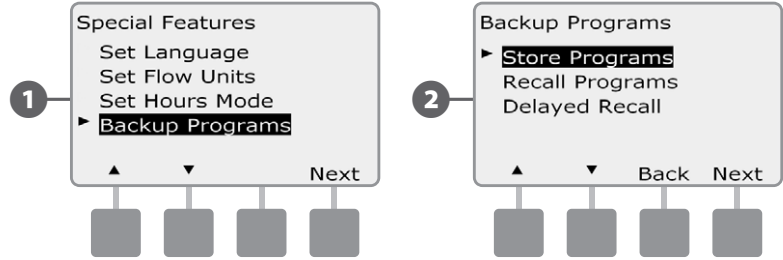

- 3 A confirmation screen appears. To Store Programs, press and hold down the Yes button for four seconds. If you're not sure, press No.
- 4 A confirmation screen appears.

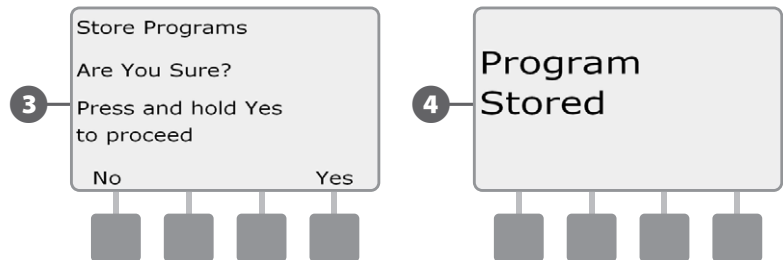

Recall Default Programs

- Turn the controller dial to Special Features.

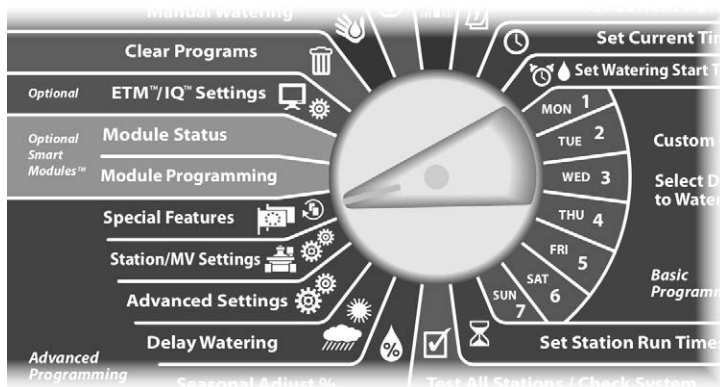

- The Special Features screen appears. Press the Down Arrow button to select Backup Programs; then press Next.
- The Backup Programs screen appears. Press the Down Arrow button to select Recall Programs; then press Next.

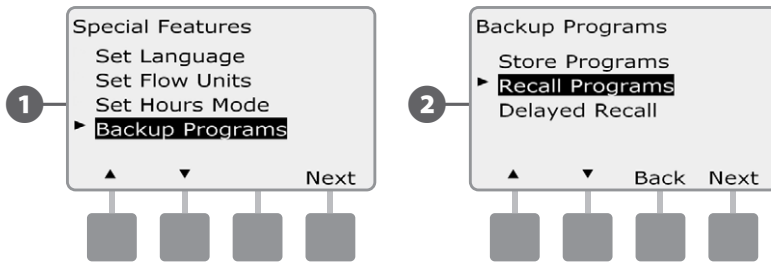

- A confirmation screen appears. To Recall Programs, press and hold down the Yes button for four seconds. If you're not sure, press No.
- A confirmation screen appears.

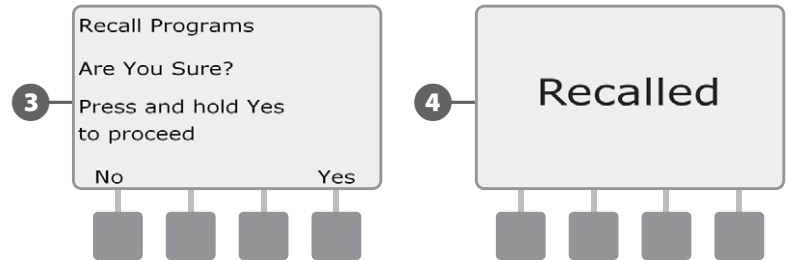

- CAUTION:** Once current programs have been replaced using Recall Programs they can not be restored.

Delayed Recall

Use the Delayed Recall feature to automatically replace the currently loaded programs with a previously stored program at a future date.

CAUTION: Once current programs have been replaced with the Delayed Recall feature, they can not be restored.

Turn the controller dial to Special Features.

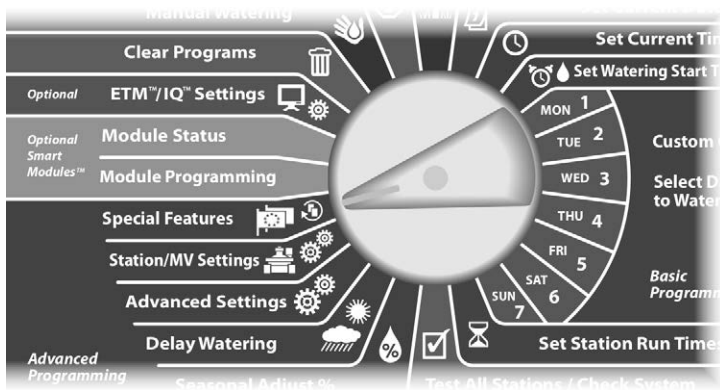

3 The Recall Delay screen appears. Press the + and - buttons to enter the number of days (from 0 to 90 days) before Contractor Defaults are restored. For example, set it to 7 days if you want your original programs to be restored in one week. If you want to clear a previously Delayed Recall, set the number of days to 0.

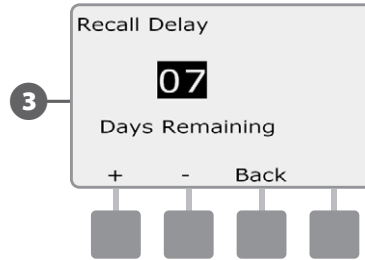

1 The Special Features screen appears. Press the Down Arrow button to select Backup Programs; then press Next.

2 The Backup Programs screen appears. Press the Down Arrow button to select Delayed Recall; then press Next.

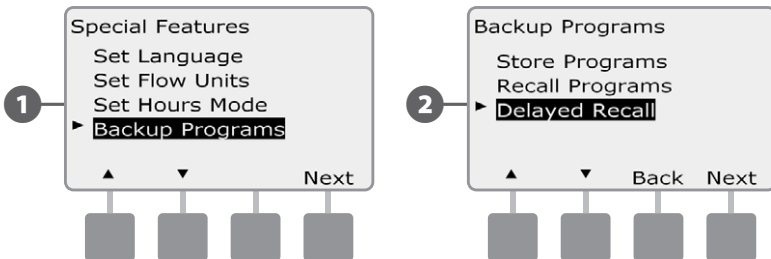

Section G - Auxiliary Operation

Clear Programs

The ESP-LXME controller allows you to clear an individual Program, all of your Programs, or to Restore the controller to its factory default condition.

CAUTION: It's recommended to back up your Programs before clearing them. The ESP-LXME controller's built in Store Programs feature can backup one set of programs. See Section F, Backup and Recall Programs for more details.

NOTE: Irrigation start days, Start Times and station Run Times will no longer be present for the cleared Programs. If no Programming exists then an Alarm will be displayed. See Section A, Alarm Conditions for more details.

Clear Individual Program

Turn the controller dial to Clear Programs.

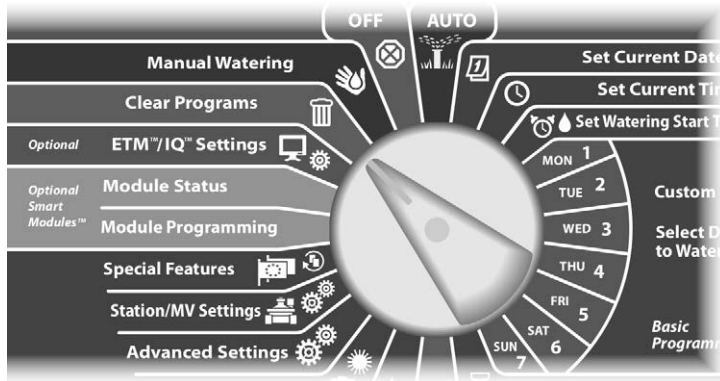

- 1 The Clear Programs screen appears with Individual Program selected; press Next.
 - 2 A confirmation screen appears. To clear the selected Program, press and hold down the Yes button for four seconds. If you're not sure, press No.
- NOTE:** If the desired program is not selected, use the Program Select switch to change it. See Section B, Program Select Switch for more details.

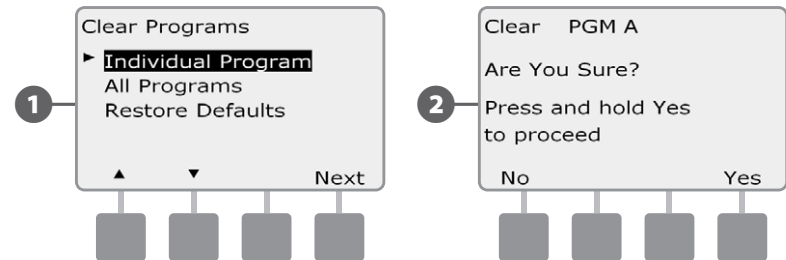

- 3 A confirmation screen appears.

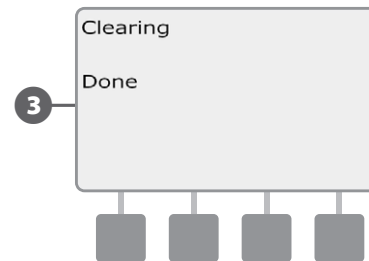

- 3 Change the Program Select switch and repeat this process to clear other Programs.

Clear All Programs

- ▶ Turn the controller dial to Clear Programs.

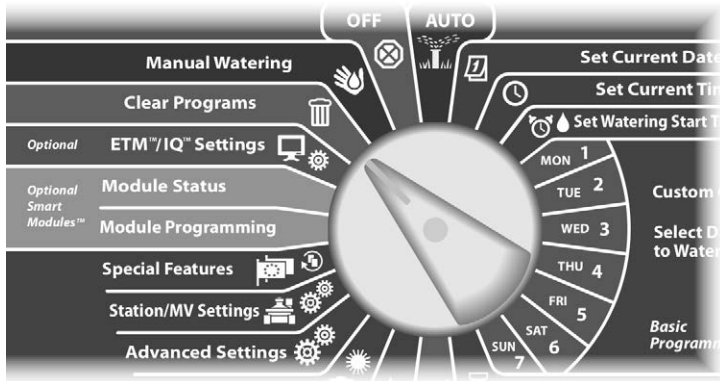

- 3 A confirmation screen appears.

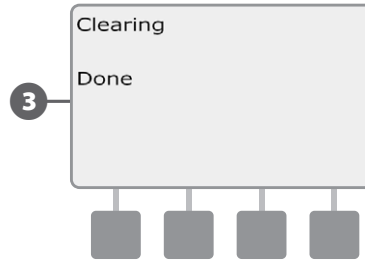

- 1 The Clear Programs screen appears. Press the Down Arrow button to select All Programs; then press Next.
- 2 A confirmation screen appears. To Clear All Programs, press and hold down the Yes button for four seconds. If you're not sure, press No.

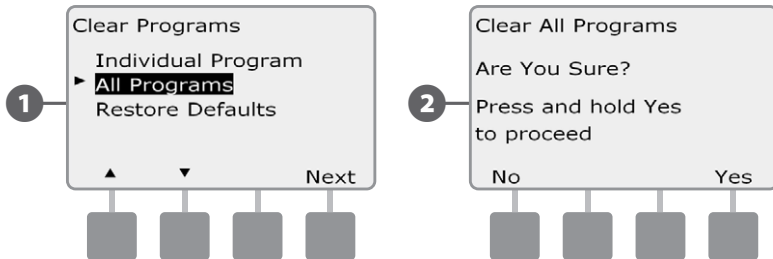

Restore Defaults

Restore the ESP-LXME controller's factory default settings.

- 1 Turn the controller dial to Clear Programs.

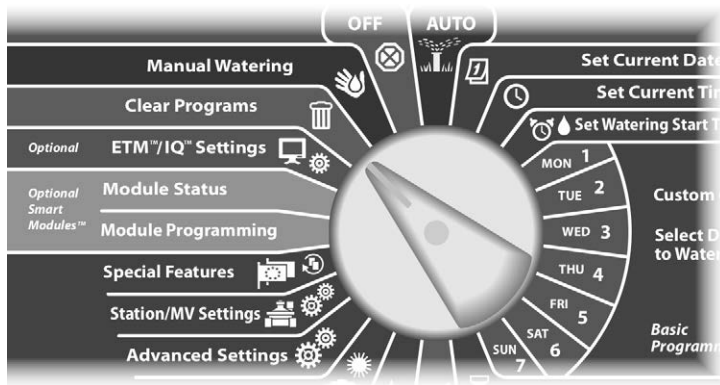

- 1 The Clear Programs screen appears. Press the Down Arrow button to select Restore Defaults; then press Next.
- 2 A confirmation screen appears. To Restore Factory Defaults, press and hold down the Yes button for four seconds. If you're not sure, press No.

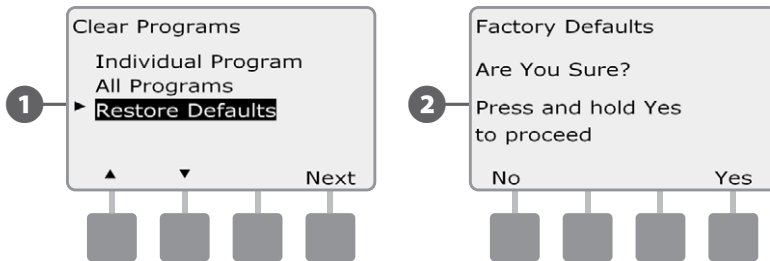

- 3 A confirmation screen appears.

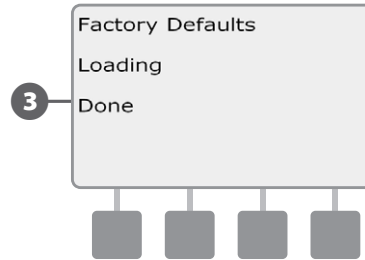

- CAUTION:** Be very careful about using the Restore Defaults option as all previous settings will be permanently cleared from system memory. Consider using the Clear All Programs option instead.

Manual Watering

The ESP-LXME controller allows you to manually start a station, a program, or to open a Normally Closed Master Valve (NCMV) to provide water to your irrigation system for manual watering.

Start Station Manually

NOTE: Manual Watering > Start Station will pause currently running programs.

Turn the controller dial to Manual Watering.

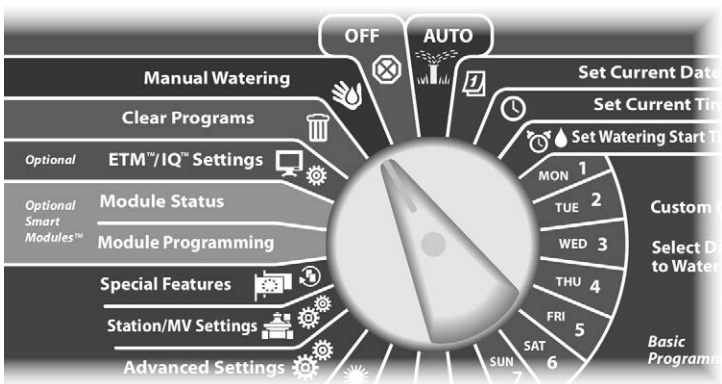

1 The Manual Watering screen appears with Start Station selected; press Next.

2 The Manual Watering screen appears. Press the + and – buttons to enter the station you want to run manually; then press Next.

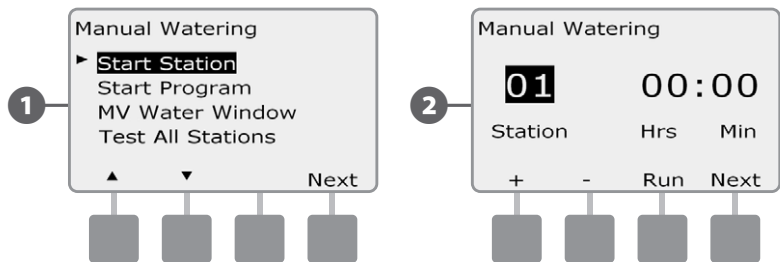

3 The Station Run Time will default to the Program Run Time. Press the + and – buttons to adjust the station Run Time (from 0 hours, 1 minute to 12:00 hours). Press the Run button to start irrigation for that station.

- Press and HOLD buttons to accelerate settings for hours and minutes.

4 A confirmation screen appears.

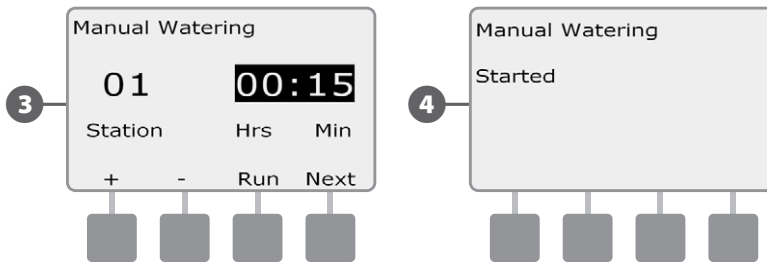

Repeat this process to manually water other stations.

NOTE: Stations will run sequentially in the order in which they were selected.

NOTE: To view the Station while running, turn the controller dial to AUTO position. You can use the Adv button to advance to the next station and the + and – buttons to increase or decrease the Run Time of the current station.

Start Program Manually

- ▶ Turn the controller dial to Manual Watering.

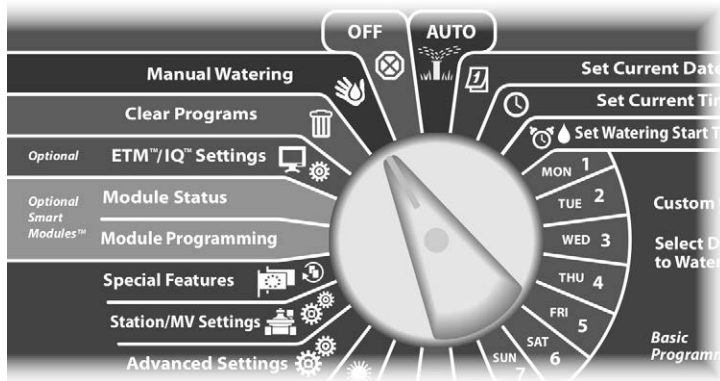

- 1 The Manual Watering screen appears. Press the Down Arrow button to select Start Program; then press Next.
- 2 The Manual Watering Start Program screen appears. Press Run to start the Program or else press Back to cancel.

! **NOTE:** If the desired program is not selected, use the Program Select switch to change it. See Section B, Program Select Switch for more details.

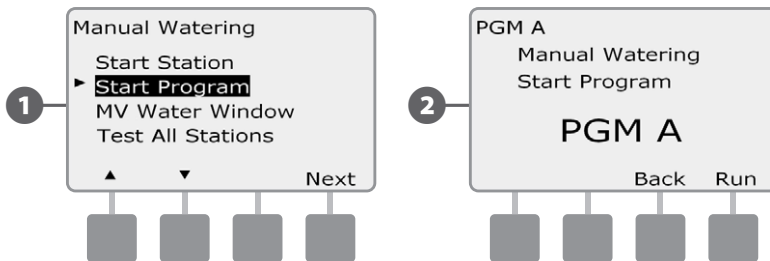

- 3 A confirmation screen appears.

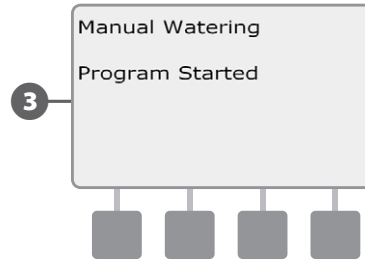

↻ Repeat this process to manually start other Programs. Programs will run sequentially in the order in which they were selected.

! **NOTE:** To view the Program while running, turn the controller dial to AUTO position. You can use the Adv button to advance to the next station and the + and – buttons to increase or decrease the Run Time of the current station.

MV Water Window

Sometimes you may want to use quick coupling valves or other manual watering methods during times when you are not irrigating. To ensure that these devices have water, you can set up an MV Water Window. The MV Water Window works the same way as other Water Windows, but instead of allowing irrigation it simply opens the Normally Closed master valve (NCMV) and allows a user-defined flow rate to coordinate with flow sensing if installed.

Set Up MV Water Window

- Turn the controller dial to Manual Watering.

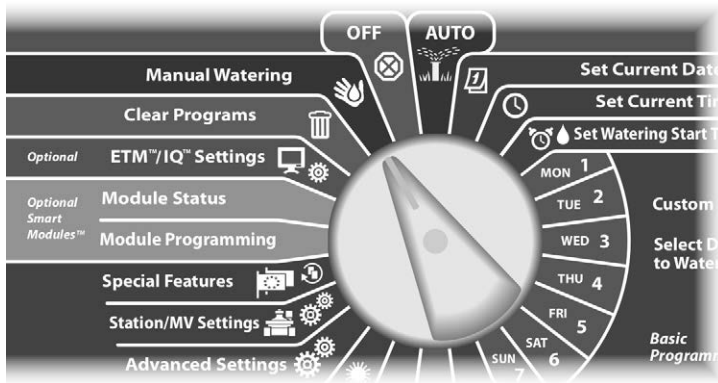

- The Manual Watering screen appears. Press the Down Arrow button to select MV Water Window ; then press Next.
- The MV Water Window screen appears with MV Water Window selected; press Next.

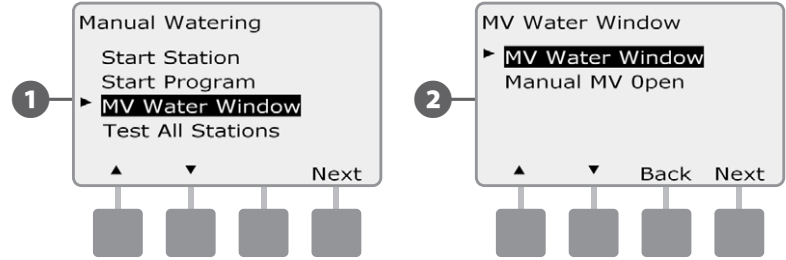

- Press the + and - buttons to set the time when the MV Water Window opens; then press Next.
 - Press and HOLD buttons to accelerate settings for hours and minutes.
- Press the + and - buttons to set the time when the MV Water Window closes. As you adjust the end time, the duration of your MV Water Window calculates automatically; then press Next.

NOTE: To clear a previously set MV Water Window, press the + and - buttons to set both the Open and Close times to OFF (between 11:59 PM and 12:00 AM).

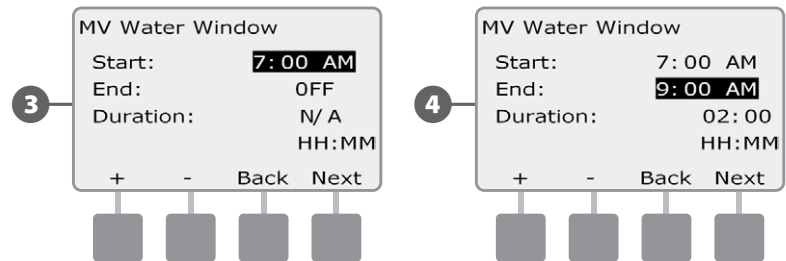

- 5 The MV Water Window Days Manual Watering Allowed On screen appears. Press the Yes button to allow MV Manual Watering to occur on a given day or press No to exclude that day.
- 6 Press the Next and Back buttons to navigate through the days of the week and repeat the selection process as desired; then press Next to navigate past Sunday.

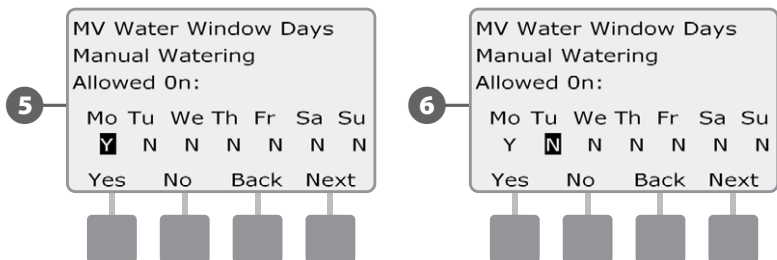

- 7 If the optional FSM-LXME Flow Smart Module is installed and FloWatch is enabled, the controller will request a maximum additional flow rate allowed for the MV Water Window. Press the + and - buttons to enter a sufficiently large value so that flow from hoses and other manual watering devices will not trigger a FloWatch SEEF High Flow alarm.

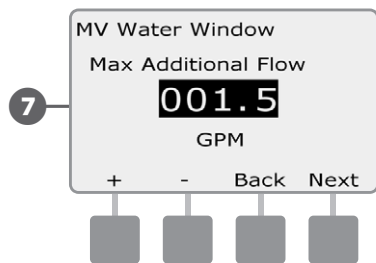

Manually Opening a MV

Occasionally it may be necessary to provide water to the system for unscheduled tasks. The Open MV feature allows you to leverage settings, such as allowable incremental flow, from your MV Water Window to open normally closed MVs for a user-selected duration.

- ▶ Turn the controller dial to Manual Watering.

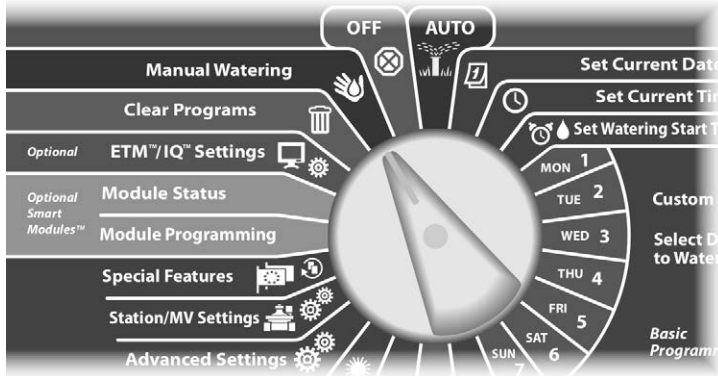

- 3 The Manual MV Open screen appears. Press the + and – buttons to set the duration (in hours and minutes) for the MV to be open; then press Next. “MV is Open” will be briefly displayed.
- Press and HOLD buttons to accelerate settings for hours and minutes.

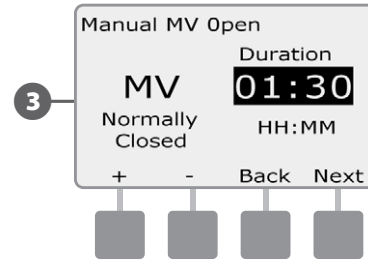

- ! **NOTE:** The Manual MV Open function can also be used with normally open master valves (NOMVs). If flow sensing is installed, using this function informs the controller that a manual flow rate should be expected, eliminating high flow (SEEF) shut down.

- 1 The Manual Watering screen appears. Press the Down Arrow button to select MV Water Window ; then press Next.
- 2 The MV Water Window screen appears. Press the Down Arrow button to select Manual MV Open ; then press Next.

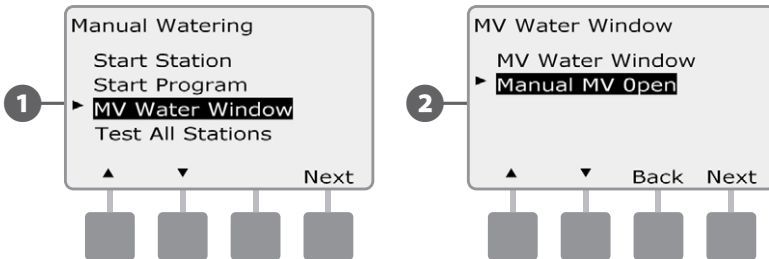

Test All Stations

You can test all stations connected to your controller by running each of them in sequence.

Sometimes this is useful after installation, for general maintenance or as a first step in troubleshooting your system.

NOTE: Only stations with programmed run times are included in the Test All Stations operation.

Turn the controller dial to Manual Watering.

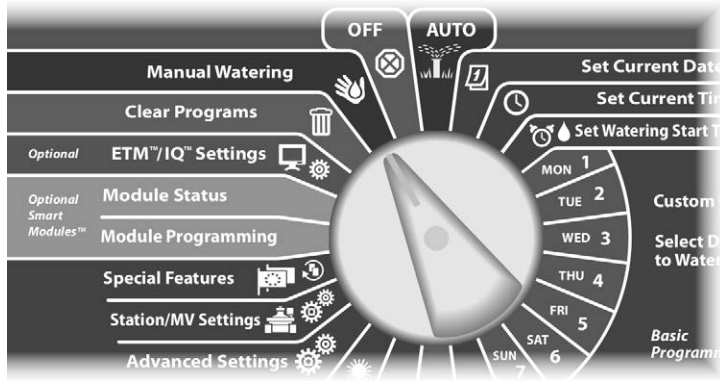

1 The Manual Watering screen appears. Press the Down Arrow button to select Test All Stations; then press Next.

2 The Test All Stations screen appears. Press the + and - buttons to adjust the Test Run Time (adjustable from 1 to 10 minutes) per station; then press Run.

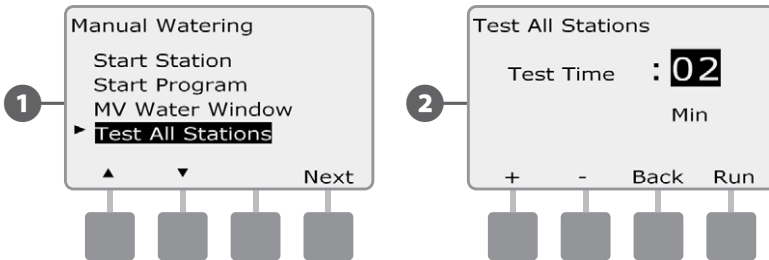

3 A confirmation screen appears.

4 Once Run is pressed, stations can be monitored and advanced by turning the dial to the AUTO position and using the Adv button. Press the + and - buttons to increase or decrease Run Time minutes for the current station.

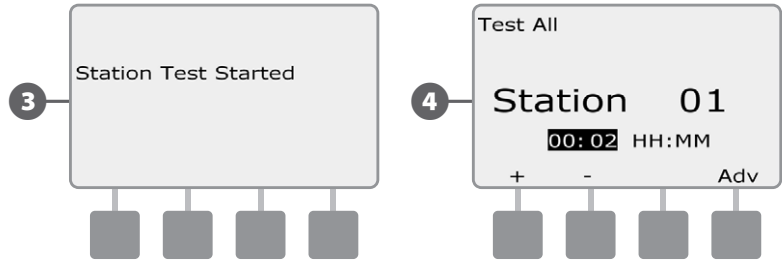

OFF

Turns off irrigation or closes the master valve.

Adjust Display Contrast

Adjust the contrast settings for the controller display for better visibility.

- Turn the controller dial to OFF.

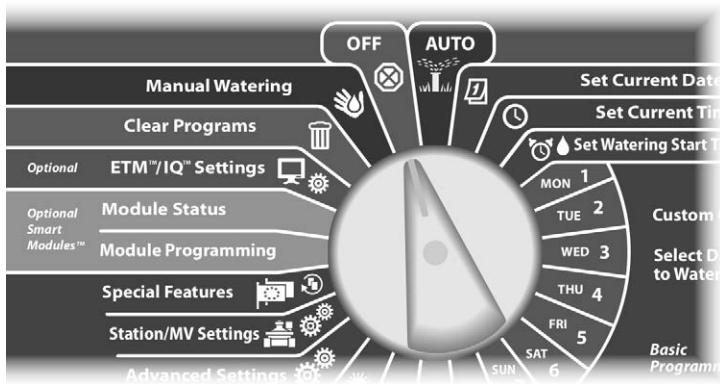

- The All Watering Off screen appears and the current contrast adjustment setting will display for 10 seconds. Press the + and - buttons to adjust contrast up or down.

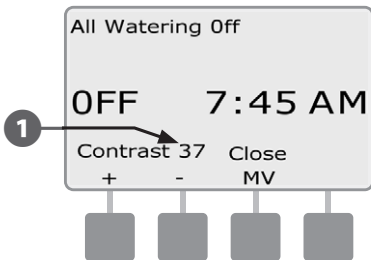

Close the Master Valve

Closes the Normally Open master valve, disabling irrigation.

 **CAUTION:** Using the Close MV function will disable all irrigation functions.

 Turn the controller dial to OFF.

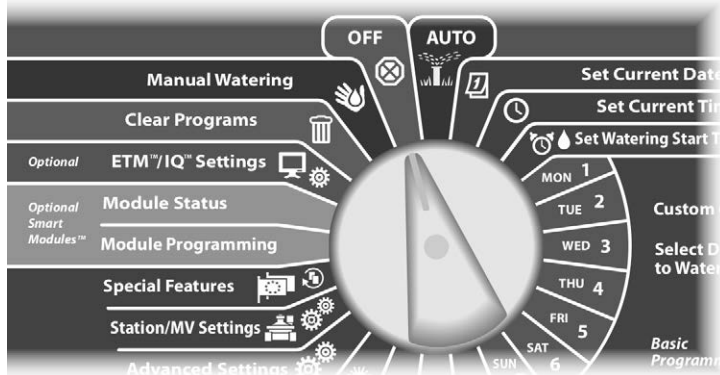

- 1 The All Watering Off screen appears. Press the Close MV button.
- 2 A confirmation screen appears. To close the normally open master valve, press and hold down the Yes button for four seconds. If you're not sure, press Back.

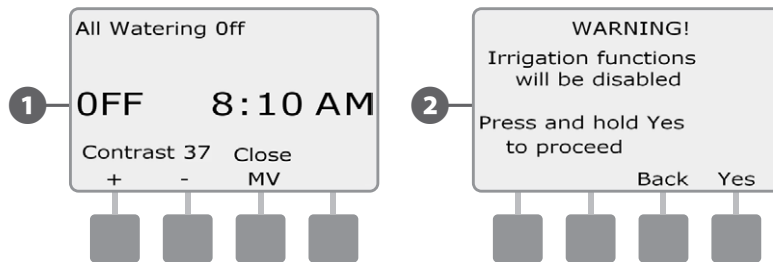

- 3 A confirmation screen appears.
- 4 The OFF dial position screen will now display the message "MV is Closed". To cancel and restore irrigation functions, turn the dial to AUTO.

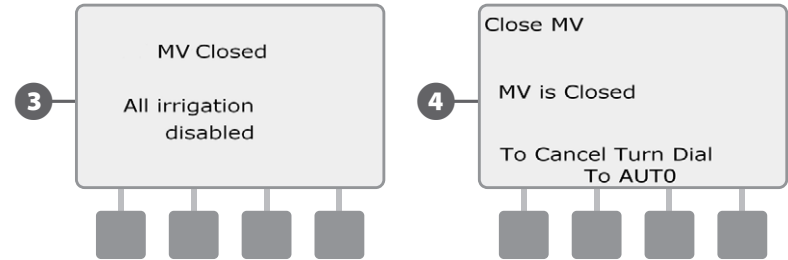

this page intentionally left blank

Section H - Installation

This section explains how to mount the ESP-LXME controller, connect the wiring, and verify proper operation.

Prepare For Installation

Installation Checklist

When installing the ESP-LXME controller for the first time, it is recommended that you complete the following steps in order.

For your convenience a check-off box is provided for each step.

- Check box contents.....Page 93
- Gather installation toolsPage 94
- Select a locationPage 95
- Mount the controllerPage 98
- Connect source powerPage 99
- Install base and station module(s).....Page 102
- Connect field wiring.....Page 105
- Complete the installationPage 108

Check Box Contents

All components below are included with your ESP-LXME controller and are required for installation. If anything is missing, please contact your distributor before proceeding.

- 1 ESP-LXME controller and modules.
- 2 Mounting hardware (5 screws, 5 plastic wall anchors).
- 3 Controller cabinet keys.
- 4 ESP-LXME Controller Installation, Programming, & Operation Guide.
- 5 ESP-LXME Controller Programming Chart.
- 6 Controller mounting template.
- 7 Station Numbering Labels

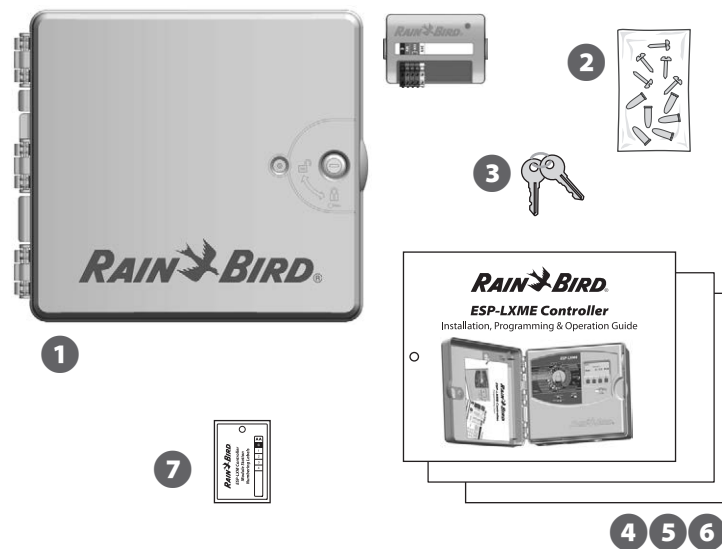

Box Contents

Gather Installation Tools

Before beginning installation, gather the following tools and materials:

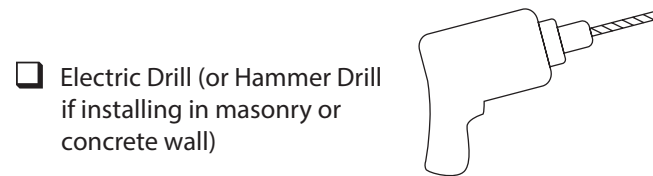
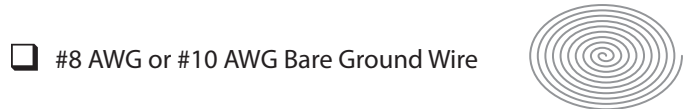
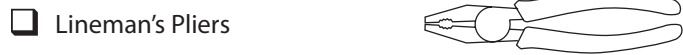
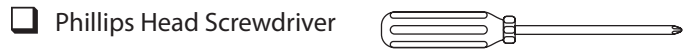
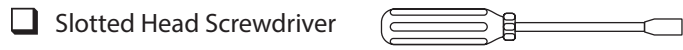

Install the Controller

The ESP-LXME controller mounts to a wall (or suitable mounting surface).

! **NOTE:** An optional metal cabinet (LXMM) and pedestal (LXMMPED) are also available for the ESP-LXME controller. If you intend to use those options, follow the installation instructions for those products before installing the controller.

⚡ **WARNING:** This controller must be installed in compliance with local electrical codes.

Select Location for Controller

Select a location that:

- Is easily accessible
- Allows for comfortable viewing
- Has a flat wall surface
- Near 120 V or 230/240 V AC power source (depending on model)
- Is safe from potential vandalism
- Is outside the range of operating sprinklers

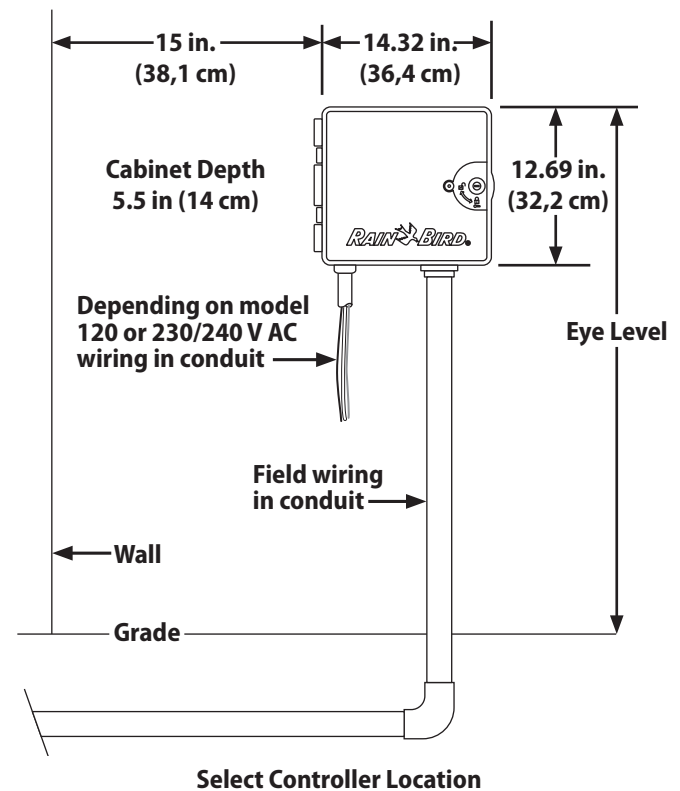

Access Controller Cabinet

Remove Cabinet Door and Front Panel

- 1 The controller comes with an outer door lock to deter vandalism and prevent unauthorized access to controller operations. If necessary, unlock the cabinet door using the supplied key.
- 2 To open the controller door: grasp the crescent-shaped handle on the right-hand-side of the outer cabinet.

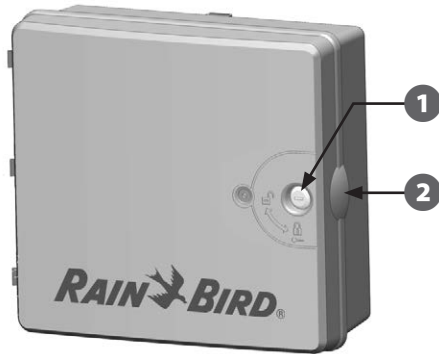

- 3 Pull it towards you to open the door, swinging it to the left.
- 4 To remove the door, carefully pull the door away from the cabinet until the door hinges separate from the plastic posts.

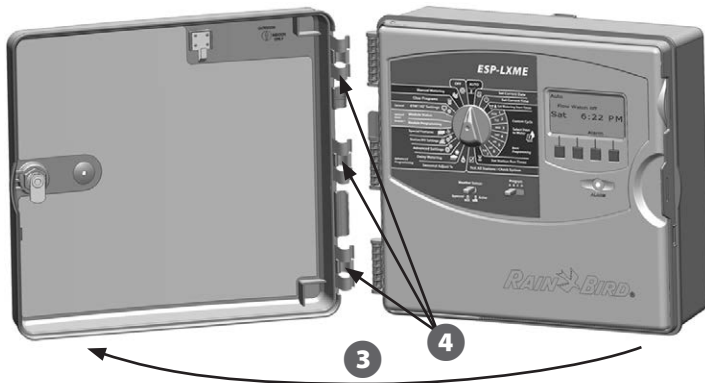

- 5 To open the controller front panel: grasp the crescent-shaped handle on the right-hand-side of the front panel.

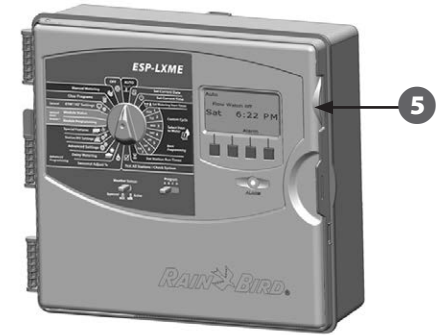

- 6 Pull it towards you to open the front panel, swinging it to the left.

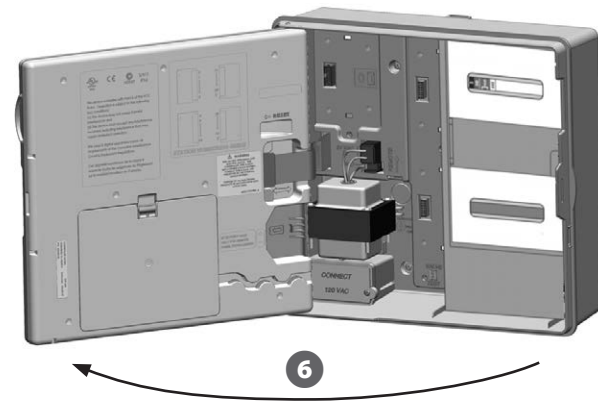

- 7** To remove the front panel: disconnect the ribbon cable from the front panel by gently pulling the connector out of the socket.



CAUTION: Be careful not to bend the pins in the sockets when attaching or detaching the ribbon cable.

- 8** Rock the front panel upward and nudge the bottom corner pin out of the lower pin-hole to remove the front panel.

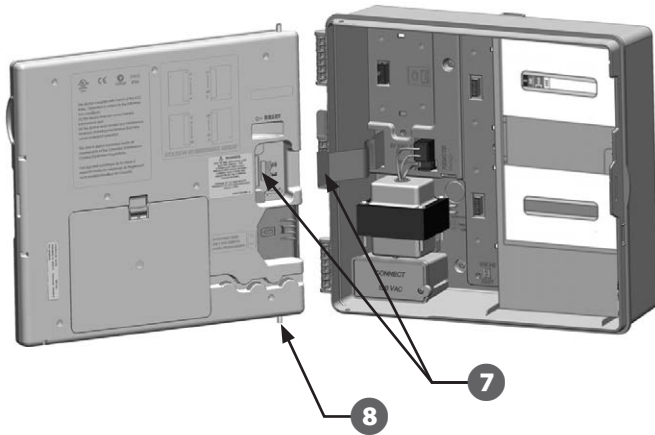

Remove Modules

Every ESP-LXME Controller ships with two modules packaged inside the cabinet, one base module (Base or Flow Smart) and one station module (SM8 or SM12). The types of modules that are included depend on the variant of ESP-LXME.

- 1** Remove both the modules and cardboard packaging from inside the controller and set the modules aside for installation later.
- 2** The top-most box contains either the Base or Flow Smart Module, with multi-color label visible through the box window.
- 3** The bottom-most box contains either an 8 or 12 Station Module, with solid blue color label visible through the box window.

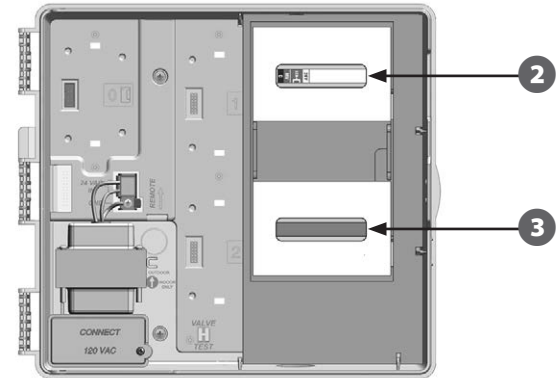

Mount Controller

- 1 Using a level, tape the mounting template to the mounting surface at approximately eye level. Make sure that at least one of the five mounting hole marks is aligned on a wall stud or other solid surface.
- 2 Use a tapping tool (or nail) and hammer to tap pilot holes through the five mounting hole marks and into the mounting surface. Then remove the template and drill holes in the mounting surface, installing wall anchors if necessary.

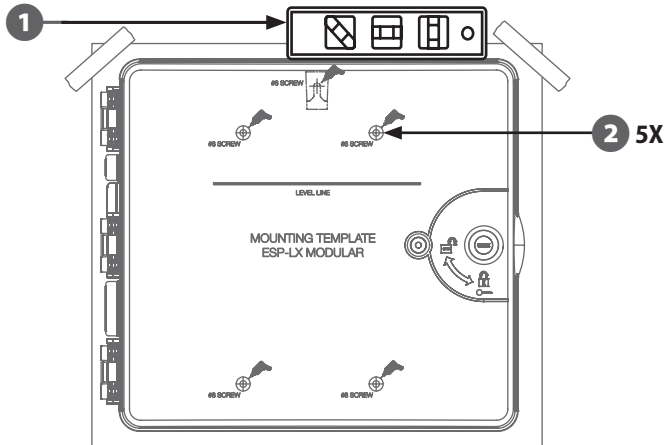

- 3 Drive the first screw into the topmost-center hole. Then hang the controller on the screw by the key-hole slot on the back of the cabinet.
- 4 Line up the controller cabinet mounting holes with the remaining pilot holes and drive the four remaining screws through the cabinet back plane into the mounting surface.

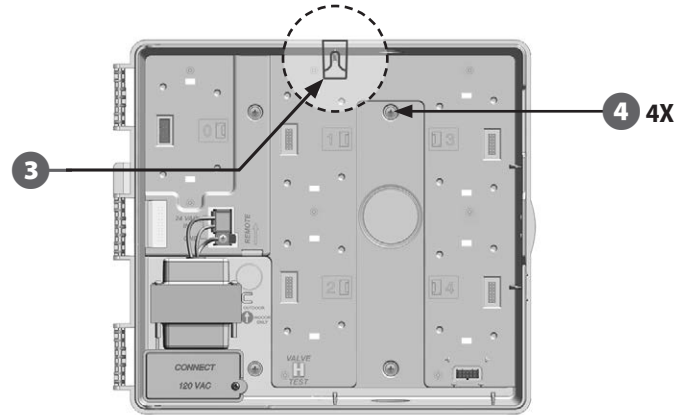

! **NOTE:** If the controller needs to be mounted on an uneven surface like stucco, place (or install) a section of exterior plywood between the controller and the wall.

Connect Power to the Controller

Surge Protection and Grounding

The ESP-LXME controller is equipped with built-in electrical surge protection. For this system to function, you must properly ground the controller.

⚡ WARNING: The ESP-LXME controller must be properly surge protected and grounded. Doing so can help prevent damage to the controller and irrigation system and also significantly reduce troubleshooting, repair time and expense. Failure to do so could result in failure of your controller and voiding the warranty.

Ensure that all grounding devices are compliant with local electrical codes.

Connect Power Source

The ESP-LXME controller has an internal transformer that reduces supply voltage (120 VAC in U.S. models; 230 VAC in international models; 240 VAC in Australian models) to 24 VAC. You will need to connect power supply wires to the transformer's three wires. (Line, Neutral, Ground)

⚡ WARNING: Electric shock can cause severe injury or death. Make sure power supply is turned OFF before connecting power wires.

⚡ WARNING: All electrical connections and wiring runs must be made according to local building codes.

- 1 Locate the transformer wiring compartment in the lower left corner of the controller cabinet. Remove the screw on the right-hand side and pull the cover off to expose the wiring compartment.

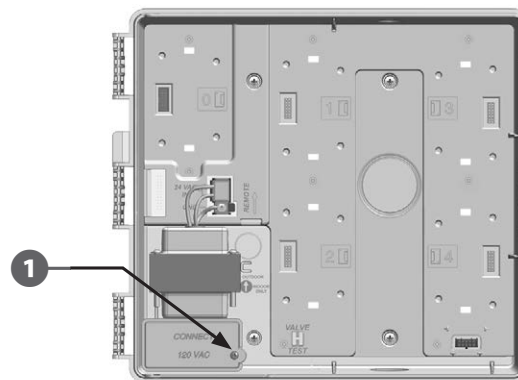

- 2 Strip the insulation from the three incoming wires to expose approximately 1/2 in (13 mm) of bare wire.
 - 3 Remove the knockout on the bottom of the cabinet below the transformer and attach a 1/2 in (13 mm) conduit fitting to the bottom entrance of the wiring compartment.
- NOTE:** 240 VAC (Australian) units do not require a conduit because the power supply cable is already installed.
- 4 Feed the three supply wires from the power source through the conduit into the wiring compartment.

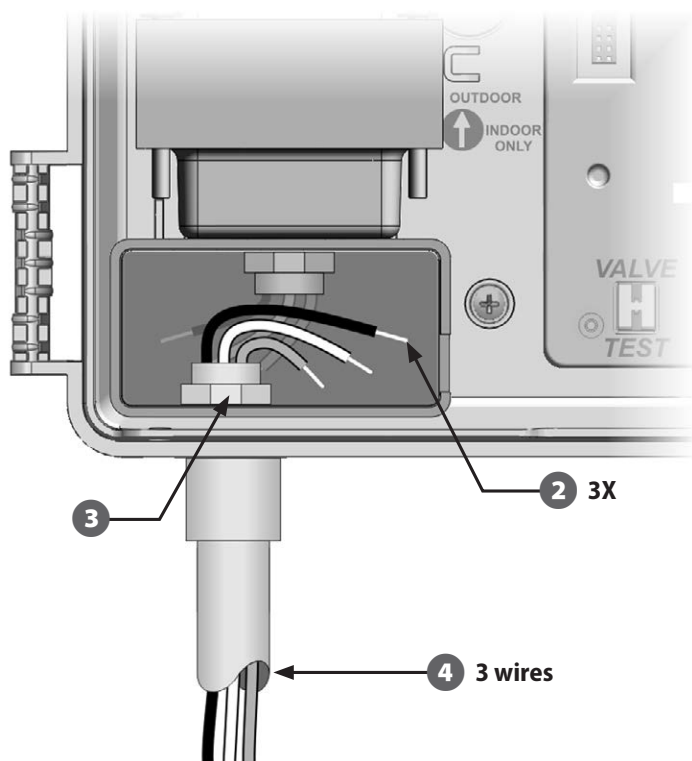

- 5 Using the provided wire nuts, connect the wires accordingly.

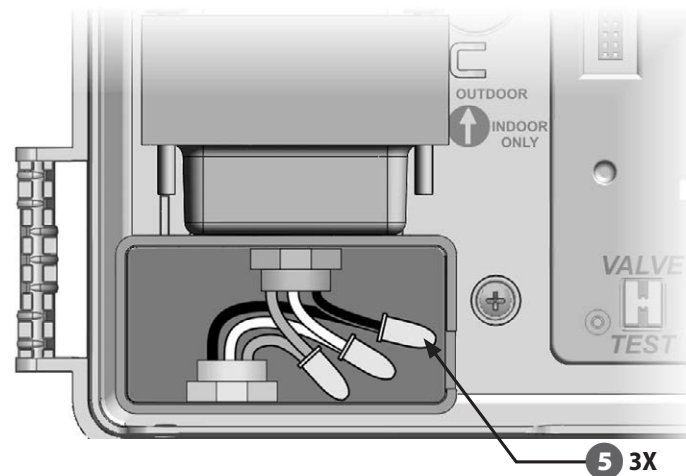

- WARNING:** The ground wire **MUST** be connected to provide electrical surge protection. You will void the controller warranty if you do not ground the controller.
- 6 Once wiring is completed, fill top of conduit with waterproof caulking to prevent insect intrusion into the controller cabinet.

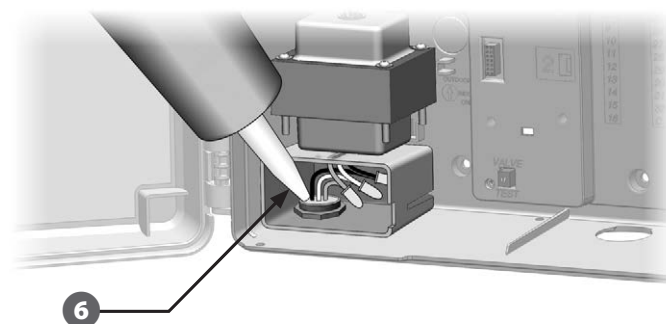

- 7 Verify that all connections are secure. Then replace the cover of the transformer wiring compartment and secure it with the screw.

Re-install Front Panel

⚡ WARNING: To prevent electrical shock, make sure all supply power is OFF before installing the front panel. Electrical shock can cause severe injury or death.

- 1 Reinstall the front panel by inserting the top corner pin into the top pin-hole; then push up and rock the bottom corner pin into the lower pin-hole.

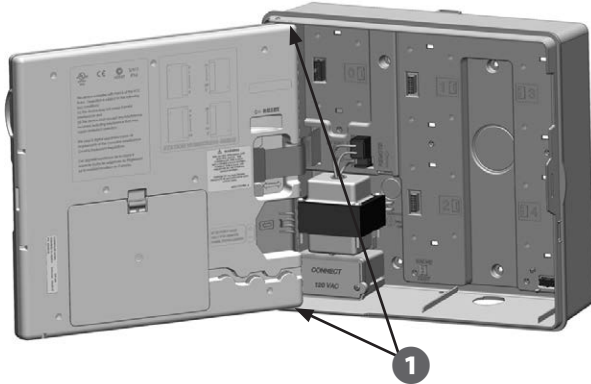

- 2 Reconnect the ribbon cable to the front panel by gently pushing the connector into the socket.

⚠ CAUTION: Be careful NOT to bend the pins in the socket.

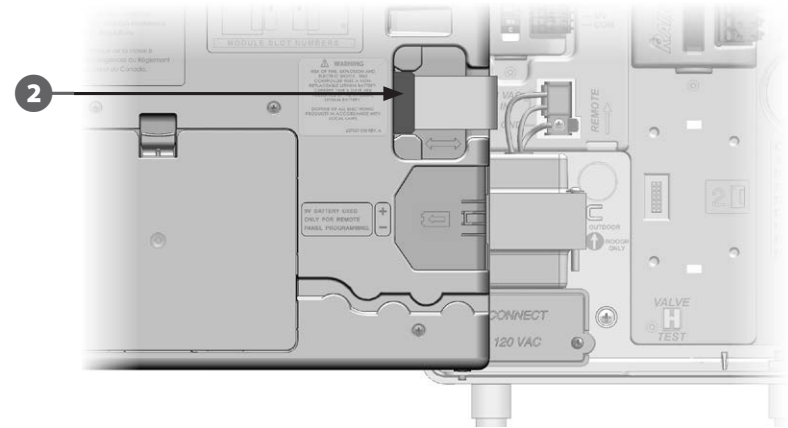

- 3 Turn on the power source.

! NOTE: The first time you power up the controller, the display will prompt you to select the language you wish to use. See Section F, Set Language for more details.

Wiring Connections	
120 VAC (US)	230 VAC (International)
Black supply wire (hot) to the black transformer wire	Black supply wire (hot) to the black transformer wire
White supply wire (neutral) to the white transformer wire	Blue supply wire (neutral) to the blue transformer wire
Green supply wire (ground) to the green transformer wire	Green-with-yellow-stripe supply wire (ground) to the green-with-yellow-stripe transformer wire

Install Modules

Install BM-LXME Base Module

Install the BM-LXME Base Module in Slot 0.

! **NOTE:** If your ESP-LXME controller included an FSM-LXME Flow Smart Module, see Section E for installation procedures.



BM-LXME Base Module

⚠ **CAUTION:** Be careful not to bend the pins in the sockets when installing the module.

! **NOTE:** The Base and Flow Smart Module include a jumper wire connecting the weather sensor (SEN) terminals. Do not remove the jumper wire unless you install a weather sensor.

1 Orient the connector on the bottom of the module with the connection socket in Slot 0 on the controller backplane.

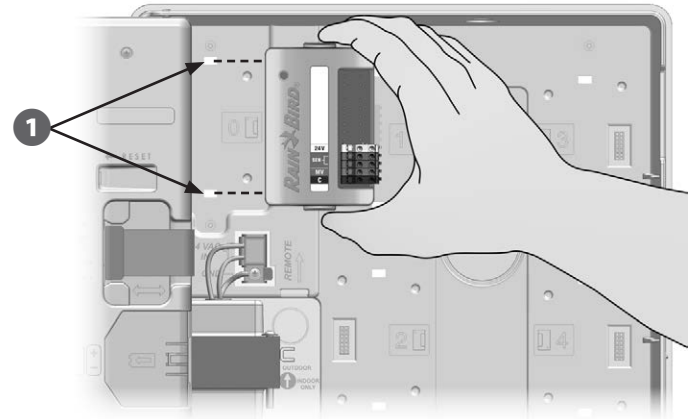

2 Carefully fasten the module onto the controller backplane, pressing firmly until it snaps into place. The red light on the module will flash on and off once if the module is installed correctly. If the light does not flash once, verify the module is seated correctly.

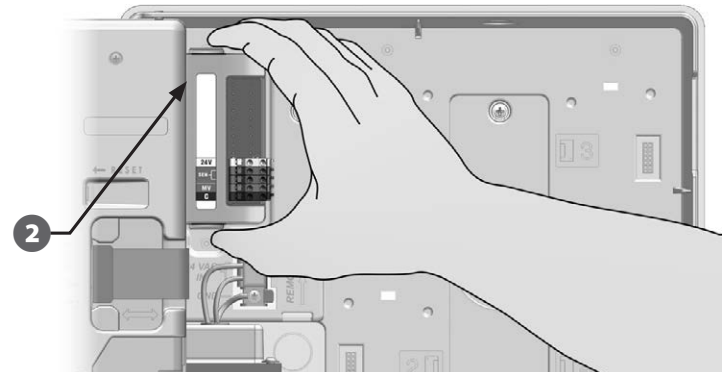

! **NOTE:** To remove the module, press in on the (two) release buttons on either side of the module.

Install Station Module

Install the station module in Slot 1 that was included with your ESP-LXME controller. Additional station modules can be purchased separately.



ESP-LXM-SM8 Station Module



ESP-LXM-SM12 Station Module



CAUTION: Be careful not to bend the pins in the sockets when installing a module.

- 1 Orient the connector on the bottom of the station module with the connection socket in Slot 1 on the controller backplane. (An ESP-LXM-SM8 is shown.)

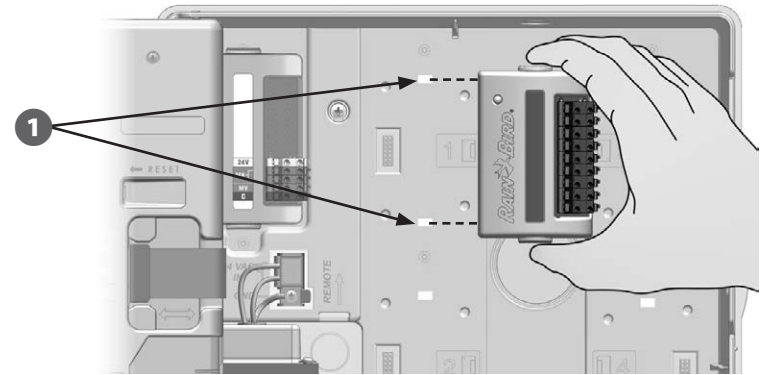

- 2 Carefully fasten the module onto the controller backplane, pressing firmly until it snaps into place. The red light on the module will flash on and off once if the module is installed correctly. If the light does not flash once, verify the module is seated correctly.

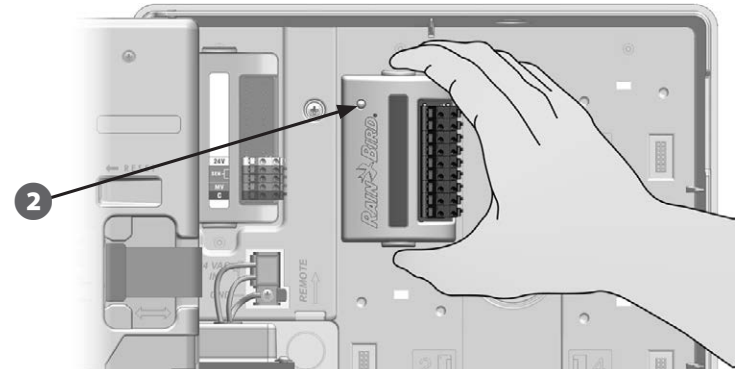

NOTE: To remove a module, press in on the (two) release buttons on either side of a module.

Dynamic Station Numbering

The ESP-LXME controller will automatically detect any new station modules that have been installed. Follow the instructions on the front panel LCD to configure a station module.

- 1 A Module Configuration screen is displayed whenever the ESP-LXM Controller detects a change in module configuration. Press Next to continue.
- 2 The Module Summary screen displays the module type detected in each module slot along with the new and old assigned station numbers. Press Accept to accept the new module configuration. (Reject will retain the current configuration.)

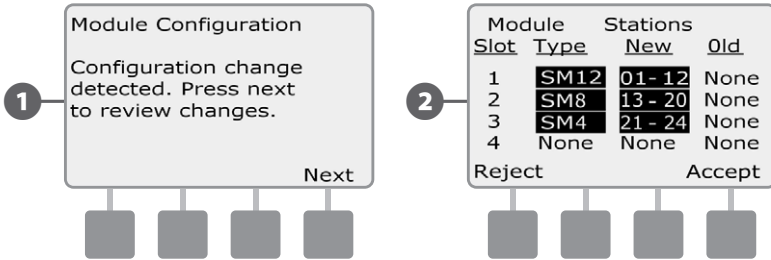

- 3 The Module Labels screen is displayed. Locate the Module Station Numbering Labels that are provided on a separate foldout sheet. Press Next to continue.
- 4 The Module Station Numbering Graphic displays a pair of letters (example: Slot 1 = Label AC) for each installed module. Find the station numbering label on the foldout sheet with the matching letter pair and place it over the blue strip on the module. Press Done to finish.

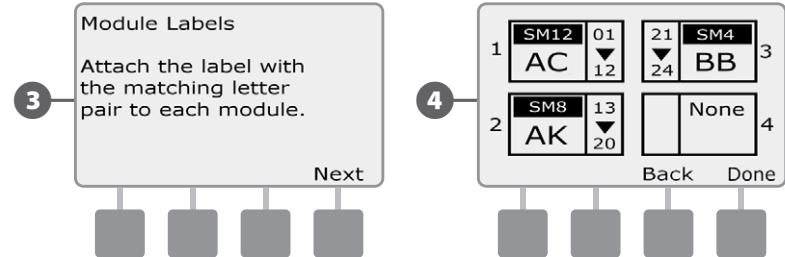

- NOTE:** The Module Status can be reviewed at any time by turning the dial to the Station/MV Settings dial position and selecting Module Status. See Module Status in Section D for details.



Connect Field Wiring

Connect Valve Wires

Field wires for valves are connected to module terminals using quick connectors. Press the swing arm of the appropriate terminal and insert the wire. When you release the spring arm, the clamp will hold the wire.

- 1 Locate (or remove) the large knockout on the bottom of the controller cabinet. Attach a conduit fitting to the bottom of the cabinet; then attach conduit to the fitting.
- 2 Feed the field wires through the conduit and into the controller cabinet.

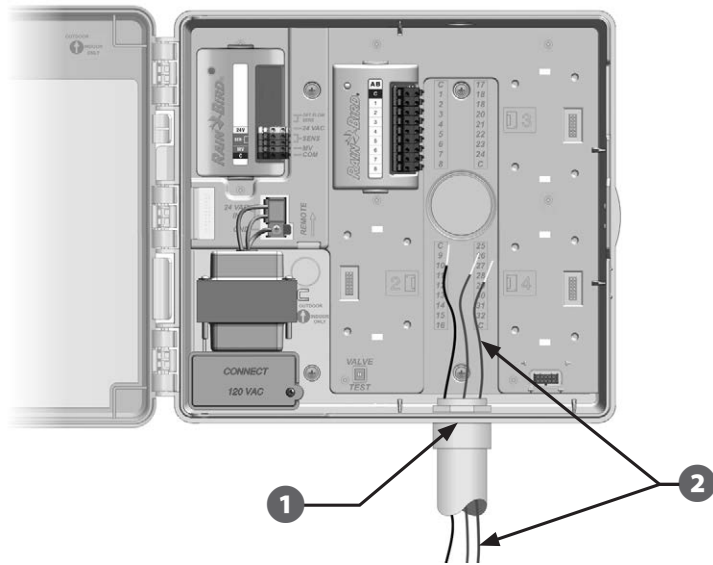

- 3 Field wires for valves are connected to module terminals using quick connectors. Press the swing arm of the appropriate terminal and insert the wire. When you release the spring arm, the clamp will hold the wire.

- 4 Strip the wire jacket back by a maximum of 1/2 inch (12 mm) and connect each valve wire to one of the numbered terminals on a station module.
- 5 Connect the common wire(s) to any one of the COM terminals on the controller. Wires used to connect the valves must be code-approved for underground installation.

! **NOTE:** Complete the following step only if your system uses a master valve or a pump start relay. The controller does not provide main power for a pump.

- 6 Connect the master valve or pump start relay wiring to the MV and COM terminals.

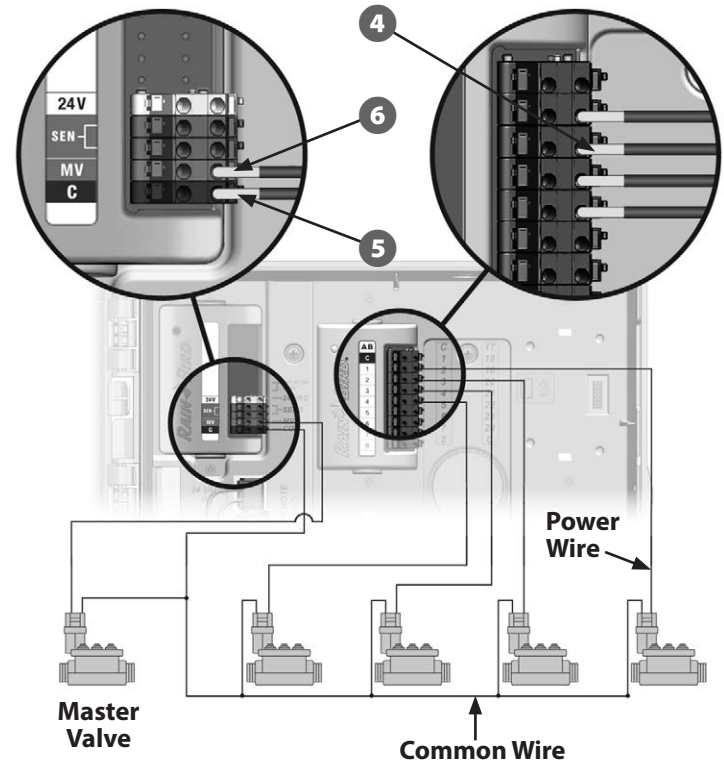

- 7 Once wiring is completed, fill top of conduit with waterproof caulking to prevent insect intrusion into the controller cabinet.

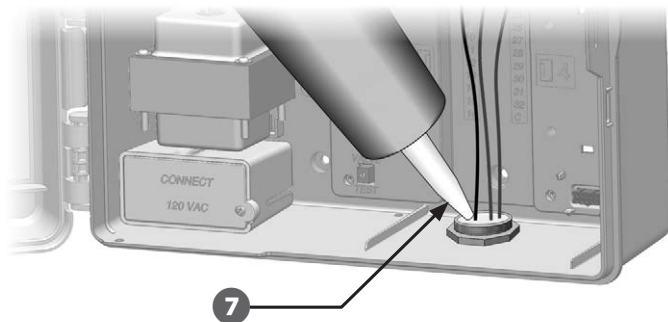

Connect Local Weather Sensor

The ESP-LXME can accept input from a single weather sensor wired directly to the controller or through a wireless receiver.

A local weather sensor can be bypassed with the sensor bypass switch on the controller front panel.

To Enable a Local Weather Sensor:

- 1 On the controller front panel, slide the Weather Sensor switch to Active.

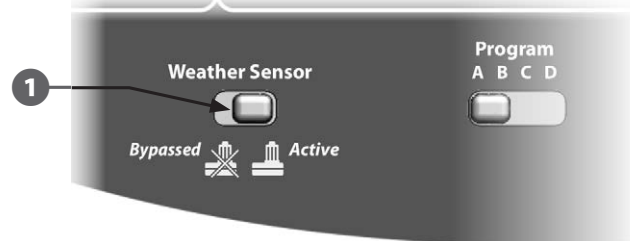

- !** **NOTE:** Follow the sensor manufacturer's instructions to correctly install and make wire connections to the sensor. Ensure the sensor installation is in compliance with all local codes.

To Connect a Wired Local Weather Sensor:

- 1 Run continuous sensor wire from the weather sensor to the ESP-LXME controller.
- 2 Route wire through knockout on the bottom of the controller.
- 3 Remove the yellow jumper wire (if present). Connect the two sensor wires to the sensor (Sen) inputs. When finished, tug gently on the wires to make sure the connections are tight.

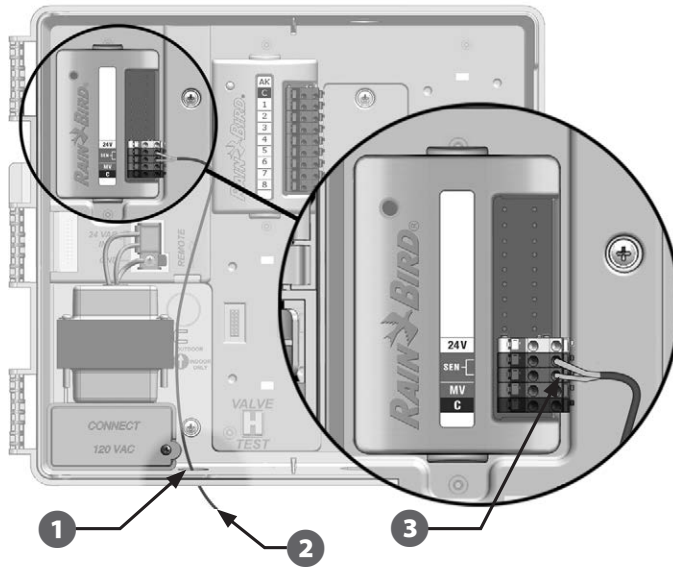

To Connect a Wireless Local Weather Sensor:

- 1 Run wire from the wireless receiver to the ESP-LXME controller.
- 2 Route wire through knockout on the bottom of the controller.
- 3 Remove the yellow jumper wire (if present). Connect the two sensor wires to the sensor (Sen) inputs, the power wire to the 24V input, and the common wire to the common (C) input. When finished, tug gently on the wires to make sure the connections are tight.

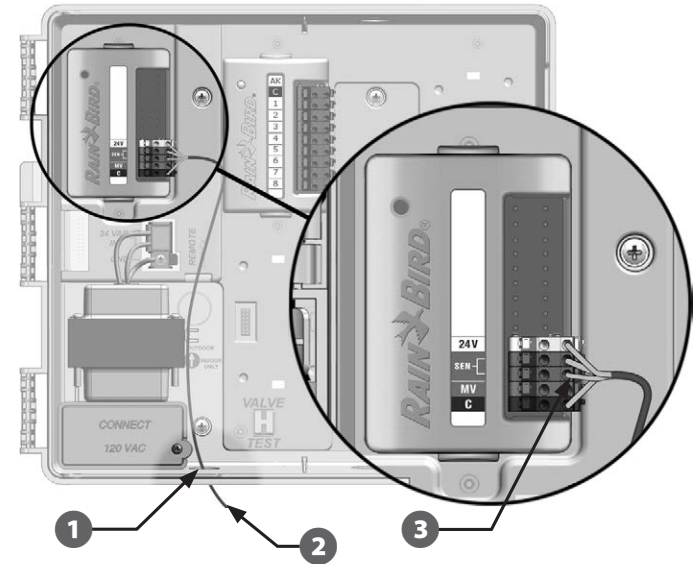

! **NOTE:** Ensure that the configuration for your controller and irrigation programs are set up correctly for your sensor. For example, if one of your programs is set up to manage your landscape lighting you may want to ensure that it's stations ignore input from a local weather sensor. See Section D, Weather Sensor, for more details.

Complete Installation

Install Front Door

- 1 Line up the three door hinges with the plastic posts on the controller.
- 2 Press the hinges onto the posts until the front door snaps into place.

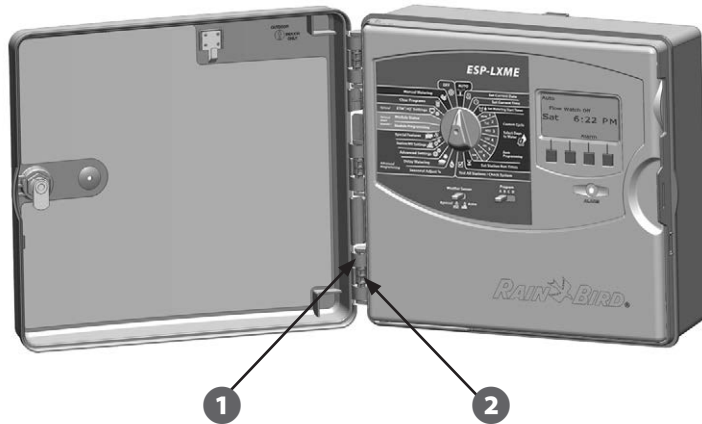

Verify Field Installation

Once some or all valves have been wired and programmed into the ESP-LXME controller you can check the electrical portion of the installation even if water is not available to test the valves.

If water is available and you would like to test some or all of your stations, the easiest way to do so is by using the Test All Stations feature of the controller. See Section C, Test All Stations for more details.

Declaration of Conformity

Application of Council Directive: 2004/108/EC

**Standards To Which
Conformity Is Declared:** EN55014-1: 2001 Class B
EN55022 Radiated Emissions
EN55022 Conducted Emissions
EN61000-3-2
EN61000-3-3
EN55014-2: 2001
EN61000-4-2
EN61000-4-3
EN61000-4-4
EN61000-4-5
EN61000-4-6
EN61000-4-8
EN61000-4-11

Manufacturer's Name: Rain Bird Corporation
Manufacturer's Address: 9491 Ridgehaven Court
San Diego, CA 92123
619-671-4048

Equipment Description: Irrigation Controller
Equipment Class: Requirements for household
appliances, electric tools and
similar apparatus

Model Numbers: ESP-LXME

*I the undersigned, hereby declare that the equipment specified
above conforms to the above Directive(s) and Standard(s).*

Place: Tucson, AZ USA

Signature: 

Full Name: Ryan L. Walker

Position: Director



RAIN BIRD CORPORATION
6991 E. Southpoint Road
Tucson, AZ 85756

© 2015 Rain Bird Corporation

® "Rain Bird", "SimulStations", "FloManager", "FloWatch", "FloZone" and "Cycle+Soak"
are registered trademarks of Rain Bird Corporation. All rights reserved.

www.rainbird.com